

PENTAX

67

Ideal-Format SLR Camera —
The Professional's Choice

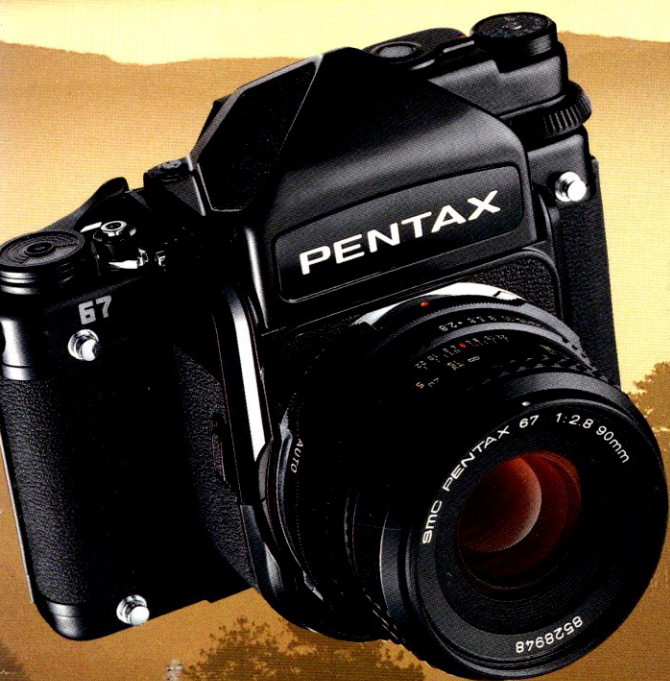

The Pentax 67 — Redefining the Photographic Image

The Pentax 67 is a unique photographic tool for the exacting professional who desires large-format image quality combined with the traditional virtues of the 35mm SLR format.

First, the Pentax 67 gives the photographer an image area four times larger than that of a 35mm camera. This means fine-grained, superior-quality image definition on enlargements. At the same time, its ideal proportions require little cropping to produce standard rectangular enlargements.



The Pentax 67's single-lens-reflex design offers versatile eye-level viewing, fast electronic focal-plane shutter and rapid-wind lever and guarantees optimum handling ease and maneuverability for active camera work, especially in the field. It also gives the photographer access to a total system of precision accessories, including a full range of interchangeable SMC Pentax 67-System lenses and accurate TTL Pentaprism Finder, for a wide variety of applications.

The Pentax 67 is a landmark camera carefully designed and perfectly crafted for demanding professionals who seek to raise their photographic skills to significant new levels. Unmatched image quality and maximum handling ease—get the best of both worlds with the Pentax 67.



A Combination of Large Image Area and

The image area of the Pentax 67 measures 55mm by 70mm, more than four times the image area of a 35mm camera. This assures the photographer of sharper resolution, superior image quality and less grain than with a smaller format—a tremendous advantage when producing enlargements.

Since the 6×7 format is ideally proportioned to match standard rectangular prints sizes, it requires very little cropping and needs to be enlarged only 3.2 times to

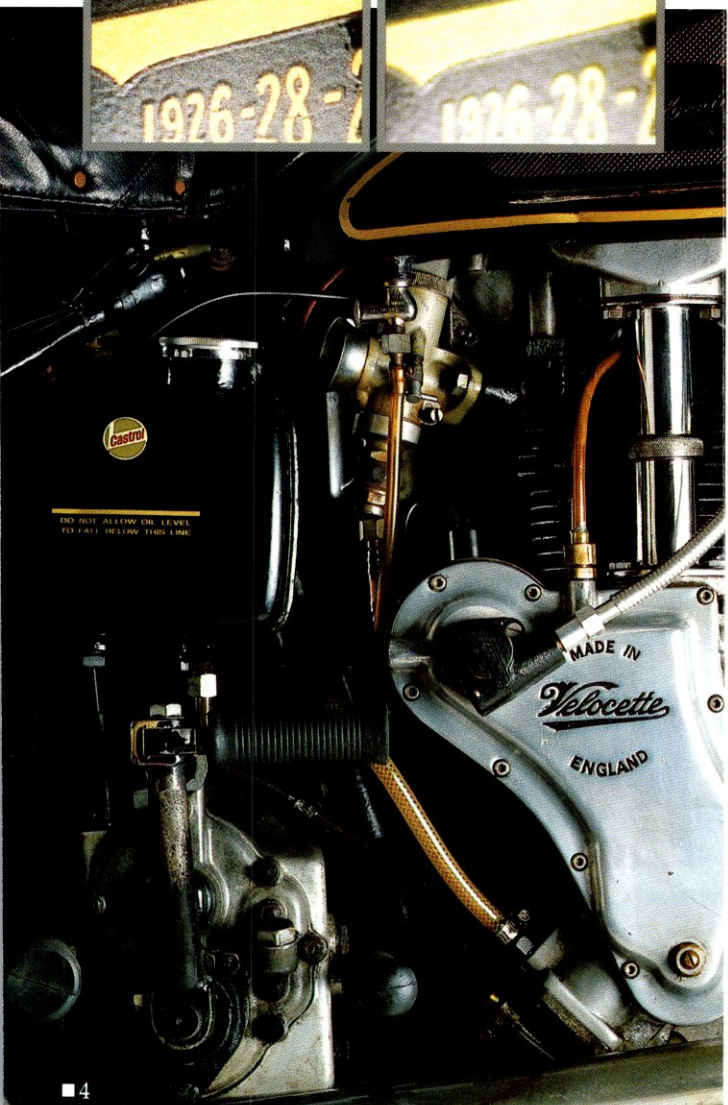

Ideal Format Means Quality Results

make an 8"×10" print. In comparison, the 6×6 format needs to be enlarged a full four times to produce the same size print.

The ideal 6×7 format is not only superior in image quality but also more versatile and efficient in darkroom work than other medium or smaller formats.

The cropped photographs on the facing page illustrate the difference in image quality of 6×7 and 35mm enlargements. It is evident that the 6×7 enlargement (left) is not only sharper but also much less grainy than the 35mm enlargement (right).

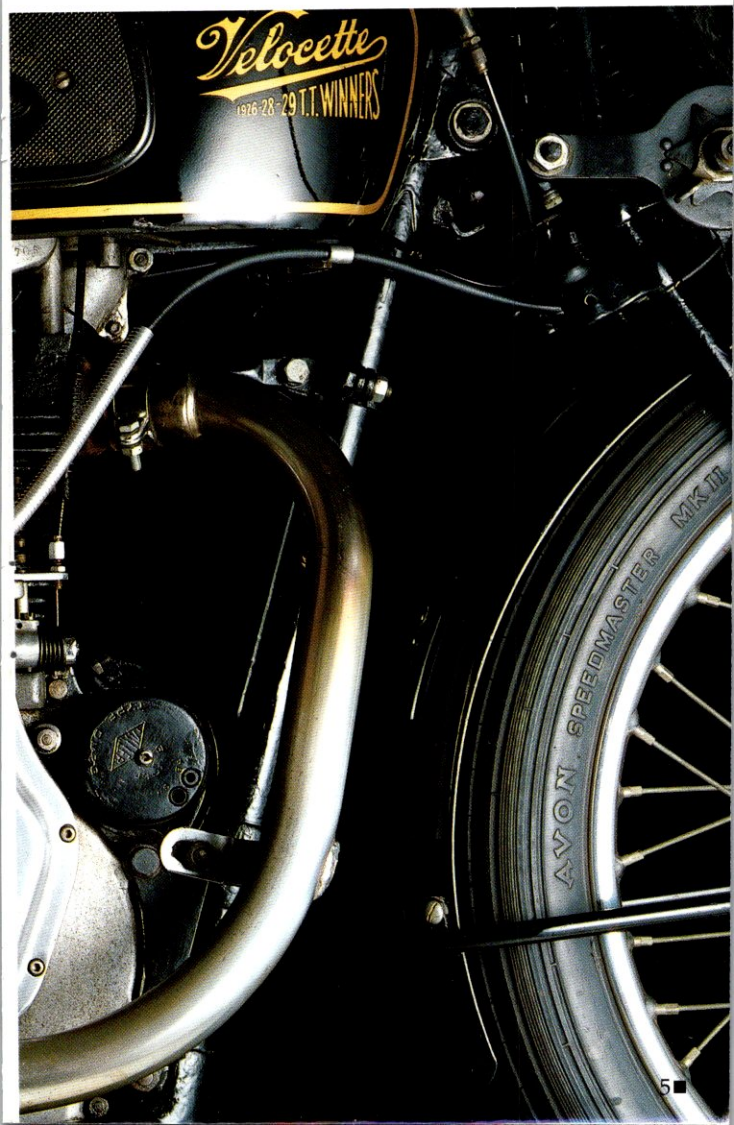

A Medium-Format Camera That Handles

The Pentax 67 is carefully designed and perfectly crafted for remarkable maneuverability and exceptional versatility equal to that of a 35mm SLR, yet it retains all the benefits of the 6×7 medium format.

Thanks to its single-lens-reflex design, the photographer can capture rapid-action subjects with the same swiftness and accuracy as a 35mm SLR, shot after shot, because all controls are laid out in much the same way as

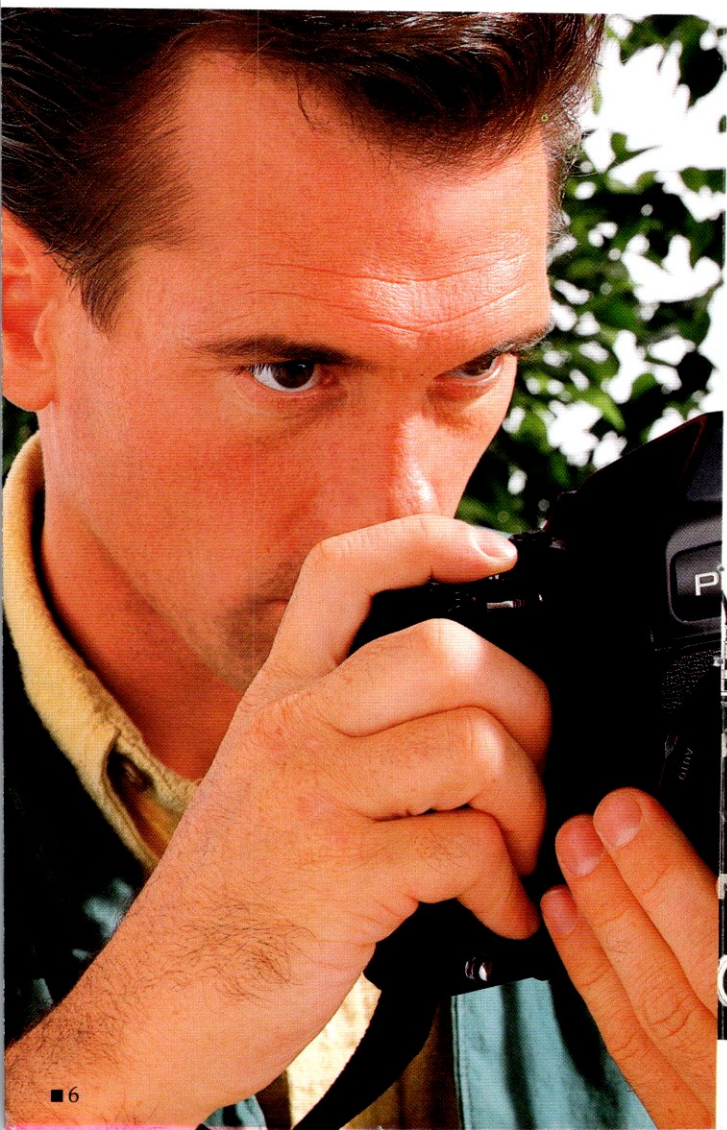

Like a Popular 35mm SLR

on a 35mm SLR. Such features as use of roll film also contribute to the reduction of its bulk and weight by making an additional film holder unnecessary.

Indeed, even long-time 35mm SLR users will quickly find the switchover to this superb camera an easy one. Yet, the advantages of the larger format will be as clear as the first image the photographer captures.



Precision Mechanical Features Promise Qu

The unrivaled versatility of the Pentax 67 results from a wide array of precision mechanical features that assure the photographer of maximum operational speed and total creative control over the subject.

Accurate Electronic Shutter

The Pentax 67's unique focal-plane shutter is electronically controlled for unmatched accuracy over its entire range of shutter speeds from one second up to a fast 1/1000 of a second—a speed uncommon in other medium-and large-format cameras.

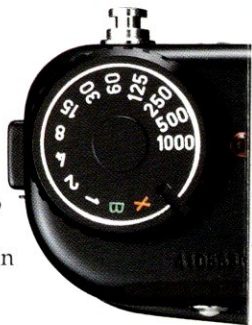

35mm SLR-Type Rapid-Wind Lever

Film winding is 35mm-SLR simple with a single 180° stroke of the rapid-wind lever, instead of a full 360° rotation or multiple strokes used in other medium-and large-format cameras. One smooth stroke advances the film and cocks the shutter so that successive shooting is fast and effortless. And the ideal positioning of the shutter release button further enhances smooth, quick shooting action.

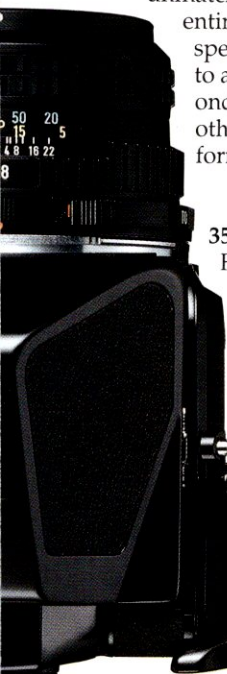

Reliable Film Transport

The image sharpness of the medium-format film depends greatly on both the film transport mechanism and adjustment of the film pressure plate. The Pentax 67's film take-up system features direct winding onto a take-up spool that follows the film's natural curve. The counter roller spool, film guard rails and film pressure plate combine to apply the exact pressure needed to hold the film gently but firmly in place and maintain film flatness for edge-to-edge sharpness.

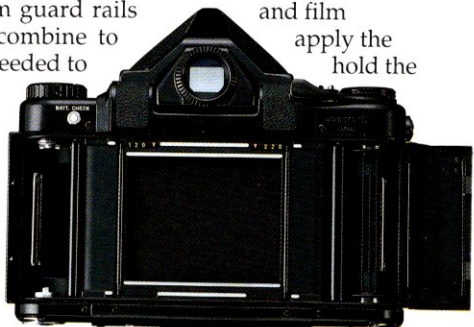

ality Images and Versatile Operation

One-Touch Film-Type Selector

The Pentax 67 accepts both 120 roll film (10 exposures) and 220 roll film (20 exposures). Simply shift the film pressure plate to the left for 120 type or to the right for 220 type, and set the exposure counter control dial to the appropriate film type. At the completion of this simple operation, the number "120" or "220" appears in a window on the back cover for confirmation.

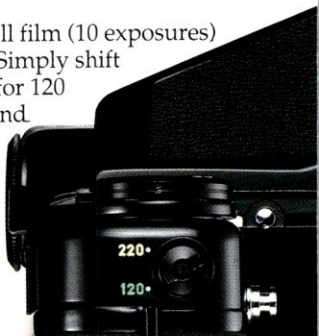

Large Swing-Back Mirror

The Pentax 67's large swing-back mirror returns instantly after each exposure to ensure an uninterrupted view of the subject. Especially with waist-level finders, the Pentax 67 offers a 100% view of the image area. A special crank-rotation mechanism minimizes mirror shock and vibration to prevent blur caused by camera

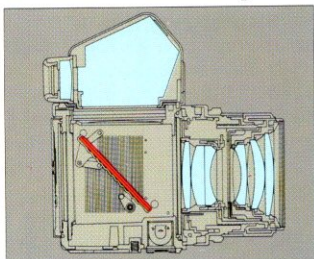

shake. For specialty work that requires extremely critical focusing or a long exposure time—such as macrophotography and ultra-telephotography—the mirror can be locked up to eliminate a shock and vibration entirely.

Quick, Effortless Lens Changes

The Pentax 67 features a dual inner/outer bayonet mount system for fast, easy lens changes, allowing the photographer to capture a variety of subjects with the best composition and perspective. This extremely durable, dependable mount also features fully automatic diaphragm operation with most of the 67-System lenses.

Dependable Power Source

A single 6V silver-oxide battery powers both the electronic focal-plane shutter and the accessory TTL Pentaprism Finder. Higher in voltage and more stable at low temperatures than alkaline batteries, this battery is an extremely dependable power source for professionals. For shooting in freezing temperatures, use of the accessory Remote Battery Cord is recommended to keep the battery warm in a pocket for more stable power supply.

A Choice of Finders and Focusing Screens

Interchangeable Finders

A truly sophisticated photographic system requires interchangeable finders for specialized applications. The Pentax 67 offers four kinds of easily interchangeable finders—two waist-level types and two pentaprism types—to provide the photographer with maximum viewing comfort and optimum ease of image composition for different types of subject. The pentaprism finders are especially valuable for active photographic work since they yield an accurate, unreversed viewfinder image coupled with the versatility of eye-level viewing.



Pentaprism Finder: Standard with the Pentax 67, this compact finder weighs only 460 grams and offers a large, bright image showing 90% of the image area. The viewfinder image is laterally correct and unreversed.

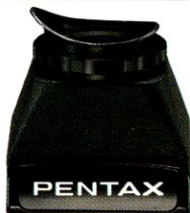

Rigid Magnifying Hood: This deluxe waist-level finder completely shields the focusing screen from ambient light for a sharp, clear viewfinder image, and shows a full 100% view of the image area. An adjustable diopter built into its 1.3× magnifier compensates for the photographer's eyesight, allowing maximum viewing comfort.

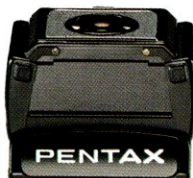

Folding Focusing Hood: This compact waist-level folding finder with a built-in 1.6× magnifier is ideal for macrophotography and super-telephotography and simplifies low-angle shooting. Its magnifier can be flipped for a 100% view of the image area.

TTL Pentaprism Finder: This accessory pentaprism finder automatically couples with the shutter speed and aperture for the "zero-method" exposure control system. The Through-The-Lens (TTL) meter reads an average of the light entering the camera with the diaphragm wide open to provide a brighter viewfinder image, which is laterally correct and unreversed.



Meets a Wide Range of Applications

Interchangeable Focusing Screen

In addition to the standard microprism/matte screen, the Pentax 67 offers four optional interchangeable focusing screens to satisfy the photographer's preference and requirements.

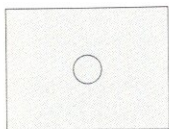

All-Matte Field: For most general work such as portrait, action and super-telephotography. The entire field is plainly visible without interference to a composition.

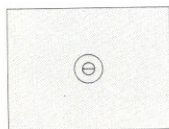

Central Split-Image Grid on Matte Field: Ideal for those who demand a relatively plain view for critical focusing or for those who wear eyeglasses.

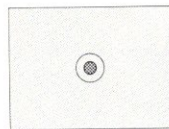

Central Microprism Grid on Matte Field: Standard with the Pentax 67, this is an excellent all-purpose screen, which allows focusing either at its central microprism spot or in the surrounding matte field.

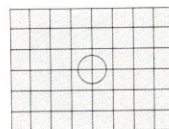

Cross-Lined Matte: The crossing lines provide accurate alignment of the subject within the image field both vertically and horizontally for such applications as architectural and indoor photography.

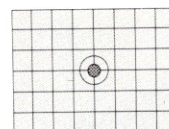

Central Microprism Grid on Cross-Lined Matte Field: The central microprism provides pinpoint focusing while the crossing lines help maintain exact alignment of the subject.

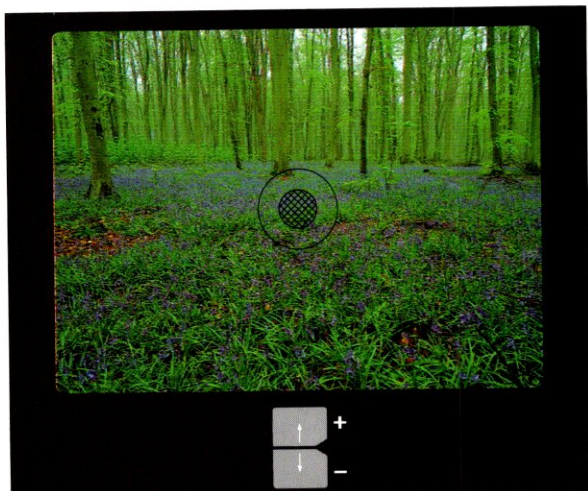

Note: The focusing screens can be easily changed at your nearest Pentax service center or distributor.

Nomenclature

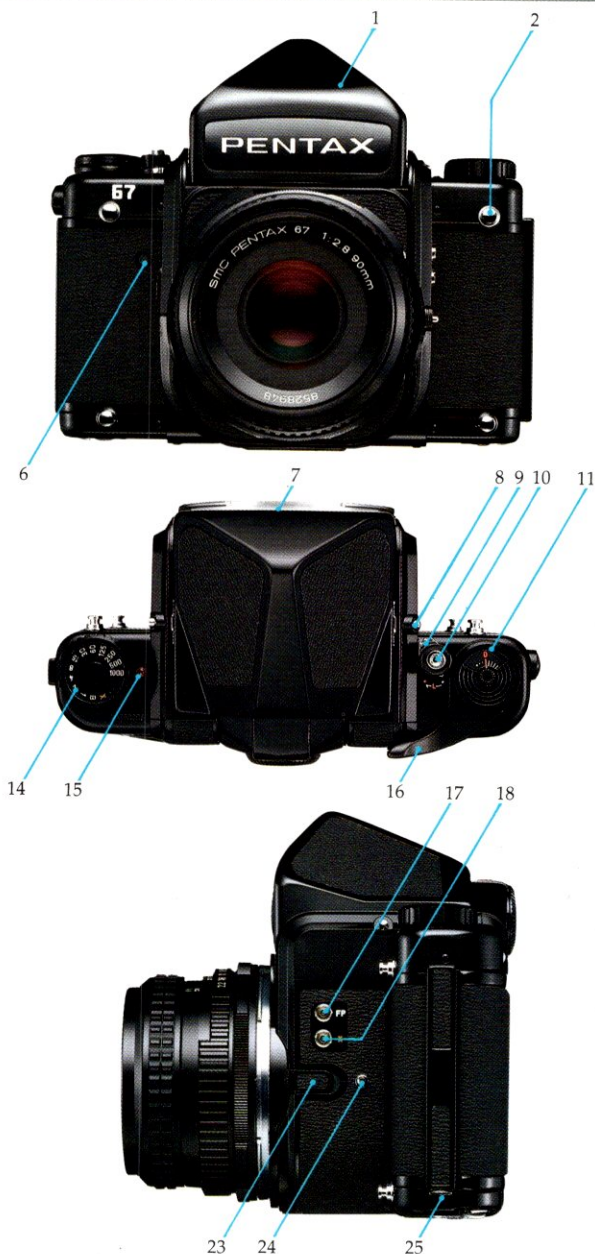

- | | |
|---------------------------------|-------------------------------|
| 1. Pentaprism | 8. Push-button side lock |
| 2. Neck strap lug | 9. Shutter lock lever |
| 3. Battery check button | 10. Shutter release button |
| 4. Eyepiece | 11. Exposure counter |
| 5. Film type indicator | 12. Battery compartment cover |
| 6. Safety device release button | 13. Tripod socket |
| 7. Large bayonet mount | 14. Shutter-speed dial |

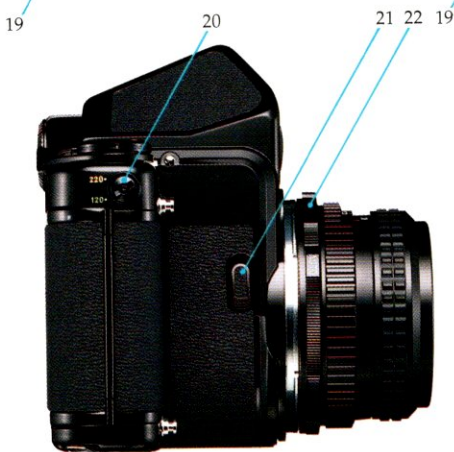
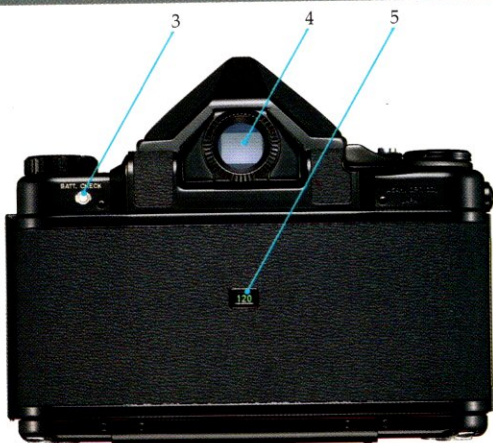

- 15. Battery check lamp
(Shutter-speed index)
- 16. Rapid-wind lever
- 17. FP-sync flash terminal
- 18. X-sync flash terminal
- 19. Film spool retainer knobs
- 20. Exposure counter control dial

- 21. Mirror lock-up lever
- 22. Depth-of-field preview lever
- 23. Lens release lever
- 24. Accessory alignment button
- 25. Back cover lock lever

The 67-System Lenses: Superbly Crafted for



One of the Pentax 67's major advantages is its interchangeable lenses, which have earned a well-deserved international reputation among leading professionals for their unsurpassed image quality.

All 67-System lenses are computer-designed at Pentax's own engineering department for optimum handling ease and smaller, lighter body construction. They are also manufactured in Pentax's own factories and extensively tested in Pentax's own laboratories to maintain the highest standards of quality.

The most distinguished feature of 67-System lenses is Pentax's exclusive Super-Multi-Coating, a unique seven-layer lens coating process that transmits a remarkable 99.8% of incident light for an extra-bright image, higher resolution, better contrast and outstanding color balance and saturation, while almost completely eliminating flare and ghost images for sharper, more lively photographs.

The photographer will soon appreciate their unequalled performance and exceptional results in almost any photographic situation.

Exceptional Image Quality

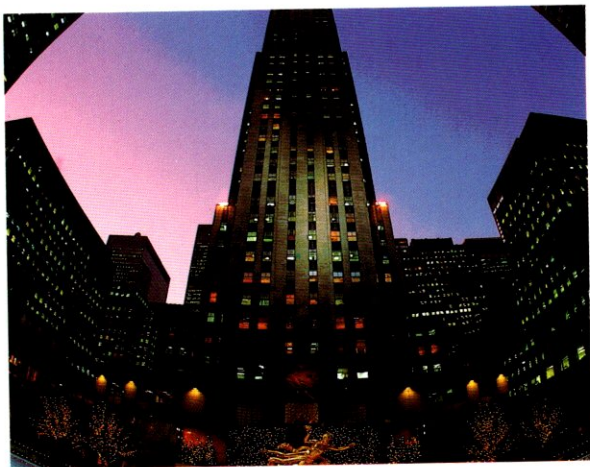

Taking in the Whole Horizon: Fish-Eye Lens

The fish-eye lens catches the overwhelming sweep and grandeur of nature with its 180° angle of view, allowing the photographer to take in an area larger than the human eye can encompass. Excellent for capturing vast natural phenomena, it also lends a touch of the exotic to smaller-scale subjects and city scenes.

**SMC PENTAX
FISH-EYE 67
35mm f/4.5**



Capturing the Broad View: Wide-Angle Lenses

These three responsive, compact wide-angle lenses can create some outstanding effects, giving the photographer the utmost latitude in photographic expressions. They feature close-focusing capabilities and unparalleled depth of field without distortion and aberration.

**SMC PENTAX 67
45mm f/4**



**SMC PENTAX 67
55mm f/4**



**SMC PENTAX 67
75mm f/4.5**



Super Eyes for the Superb Camera: Standard Lenses

The high-performance standard lenses are extremely versatile and suited for almost all general photographic purposes. They approximate the natural viewing perspective of the human eye and provide true-to-life color rendition and outstanding sharpness.

**SMC PENTAX 67
90mm f/2.8**

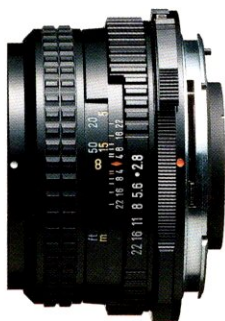

**SMC PENTAX 67
105mm f/2.4**

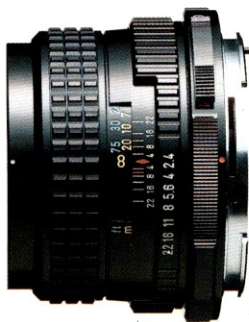

Extending the Vision: Telephoto Lenses

A selection of compact, lightweight telephoto lenses are available to meet the demands of both field and studio applications—from medium-range portraits to distant action shots. In addition, the SMC Pentax 67 LS 165mm f/4 lens features a built-in leaf shutter for studio work requiring high-speed flash synchronization.



SMC PENTAX 67
165mm f/2.8



SMC PENTAX 67 LS
165mm f/4



SMC PENTAX 67 200mm f/4



SMC PENTAX 67 300mm f/4



SMC PENTAX 67
500mm f/5.6



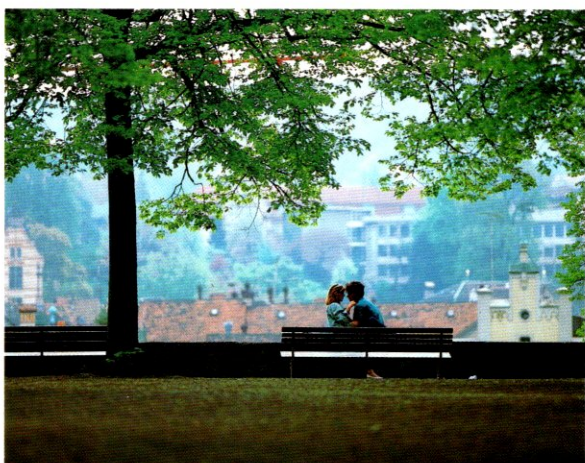

**REAR
CONVERTER
2X**



**REAR
CONVERTER
1.4X**

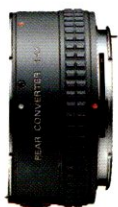

SMC PENTAX-M*67 400mm f/4 ED(IF)

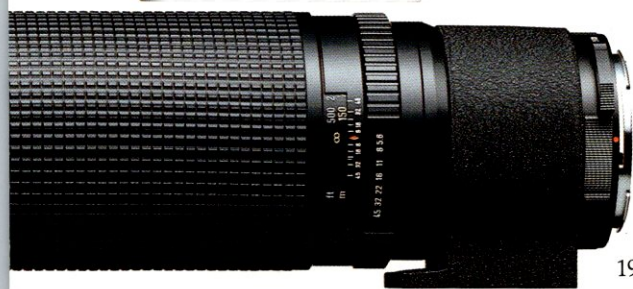

Going the Distance: Super Telephoto Lenses

With a great photographic reach, these super telephoto lenses lend a dynamic air and intensified effect to the subject by packing in foreground and background elements with extremely shallow depth of field and extraordinary magnification.

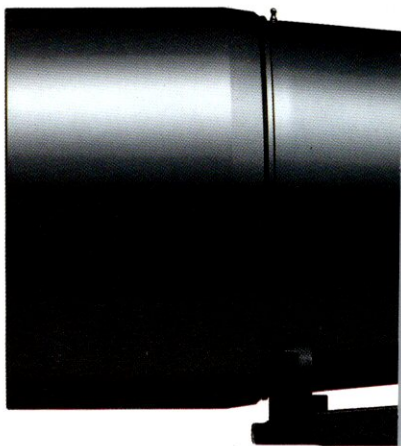

SMC PENTAX-M*67 800_{mm} f/6.7 ED (IF)

SMC REFLEX TAKUMAR 67 1000_{mm} f/8



SMC TAKUMAR 67 600mm f/4



**SMC TAKUMAR 67
800mm f/4**



REAR CONVERTER T5-1.4X



Creating Different Looks: Special-Application Lenses

For Close-up Work

The SMC Pentax 67 Macro 135mm f/4 lens captures dramatic close-up images. Its medium-telephoto focal length provides plenty of room for the subject while its large maximum aperture provides a bright viewfinder image to make critical focusing easier.



SMC MACRO PENTAX 67 135mm f/4

For Elegant Portraits

The SMC Pentax 67 Soft 120mm f/3.5 lens offers a large amount of soft-focus control to create varying degrees of soft-focus effect around the subject. When combined with one of the Pentax rear converters, it can produce even more striking effects—especially in portrait photography.

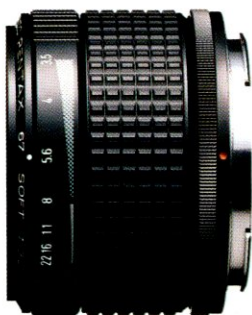

SMC PENTAX 67 SOFT 120mm f/3.5



For Architectural Subjects

The SMC Pentax Shift 67 75mm f/4.5 lens allows the photographer to correct or emphasize converging lines in the image. With a maximum shift of 20mm in all directions, this lens is an indispensable tool in architectural photography.

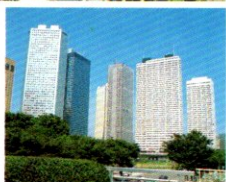

SMC PENTAX SHIFT 67 75mm f/4.5

Pentax 67-System Lens Specifications

Name of Lens	Lens Construction (Groups-Elements)	Angle of View (Degrees)	Diaphragm	Minimum Aperture	Minimum Focusing Distance (m) (ft.)		Maximum Diameter & Length (Ømm × mm)	Weight (g) (oz.)		Filter Size (mm)
SMC Pentax Fish-Eye 67 35mm f/4.5	7—11	180	FA	22	0.45	1.5	102 × 73	920	32.2	#
SMC Pentax 67 45mm f/4	8—9	89	FA	22	0.37	1.2	91.5 × 57.5	485	17.0	82
SMC Pentax 67 55mm f/4	7—8	78	FA	22	0.35	1.1	92.5 × 78.5	725	25.4	77
SMC Pentax 67 75mm f/4.5	4—5	61	FA	22	0.7	2.3	91.5 × 81	560	19.6	82
SMC Pentax 67 90mm f/2.8	5—7	53	FA	22	0.65	2.1	91.5 × 49	480	16.8	67
SMC Pentax 67 105mm f/2.4	5—6	46.0	FA	22	1.0	3.3	91.5 × 60	590	20.7	67
SMC Pentax 67 165mm f/2.8	5—6	30.0	FA	22	1.6	5.2	91.5 × 98.5	835	29.2	67
SMC Pentax 67 LS 165mm f/4*	4—5	30.0	FA	32	1.6	5.2	92.5 × 77	780	27.3	77
SMC Pentax 67 200mm f/4	4—5	25.0	FA	32	1.5	4.9	92.5 × 135	795	27.8	77
SMC Pentax 67 300mm f/4	5—5	17.0	FA	45	5	16.4	92.5 × 186	1,430	50.1	82
SMC Pentax-M* 67 400mm f/4 ED[IF]	9—9	12.5	FA	45	2.8	9.2	132.5 × 305	3,700	129.5	67
SMC Pentax 67 500mm f/5.6	4—4	10.2	FA	45	8	26.2	106.5 × 398	3,200	112.0	95
SMC Takumar 67 600mm f/4	5—6	8.5	M	45	12	39.4	170 × 370	6,000	210.0	77
SMC Takumar 67 800mm f/4	6—6	6.4	M	45	20	65.6	236 × 611	17,700	619.5	77
SMC Pentax-M* 67 800mm f/6.7 ED[IF]	8—9	6.4	FA	45	8	26.2	150 × 565	6,500	227.5	67
SMC Reflex-Takumar 67 1000mm f/8	6—9	5.1	ND	—	35	114.8	180 × 352	6,660	233.1	##
SMC Pentax 67 Macro 135mm f/4	3—5	36.5	FA	32	0.75	2.5	91.5 × 95	620	21.7	67
SMC Pentax 67 Soft 120mm f/4.5	3—4	40.5	M	22	0.75	2.5	89 × 63.5	520	18.2	77
SMC Pentax Shift 67 75mm f/4.5	8—9	61	M	32	0.7	2.3	97 × 106.5	950	33.3	82

+....Leaf shutter built in FAFully automatic ND....Controlled by ND filters #....UV, Y2, O2 & R2 filters built in ##....Skylight, Y2, R2 & ND filters built in

Note: Lens length does not include mount portion.

Flash System

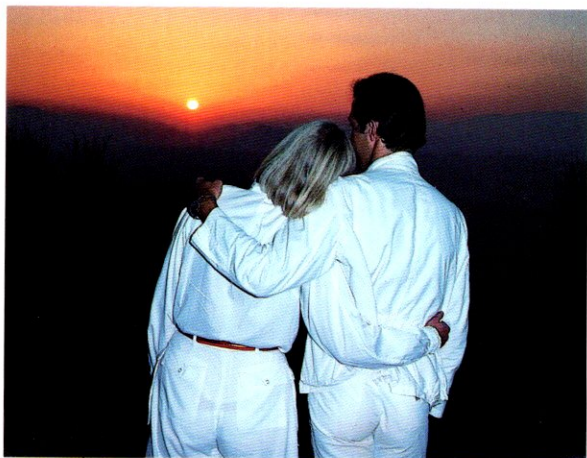

When the photographer needs responsive, reliable illumination for the subject, the combination of Pentax's AF400T Dedicated Flash, 67-System Bracket and 4P Sync Cord is capable of producing professional results shot after shot. When used in the Auto Flash mode, the AF400T measures the amount of light reflected off the subject and controls the amount of discharge to ensure a perfect exposure — all automatically.



A Wide Selection of Accessories to Improve

A wide variety of peripherals that round out the outstanding 67-System are available almost any photographic assignment, ranging from macrophoto accessories and copying aids to metering instruments and storing/carrying devices. The Pentax 67-System is a total, professional photographic system that optimizes photographic opportunities for the truly demanding professional.

Auto Bellows: Combined with the 105mm f/2.4 standard lens, it offers a magnification ranging from 0.5 \times to 3.3 \times . Automatic diaphragm operation is retained with the aid of the Double Cable Release II, even when the lens is mounted in reverse. All lenses from 90mm to 300mm can be used.

Auto Extension Tube Set (No.1, No.2 & No.3): Used singly or in any combination, this three-tube set can be used with lenses from a 55mm wide-angle to a 300mm telephoto. It offers a maximum magnification of 1.07 \times when used with the 105mm f/2.4 standard lens. Automatic diaphragm operation is retained.

Extension Tube Set A: Used singly, together or in combination with a rear converter, this two-piece set produces a 0.23 \times magnification and reduces a minimum focusing distance of super telephoto lenses in the 400mm—800mm range (excluding the M* 400mm, 500mm and M* 800mm) down to 2.75m (9 ft.).

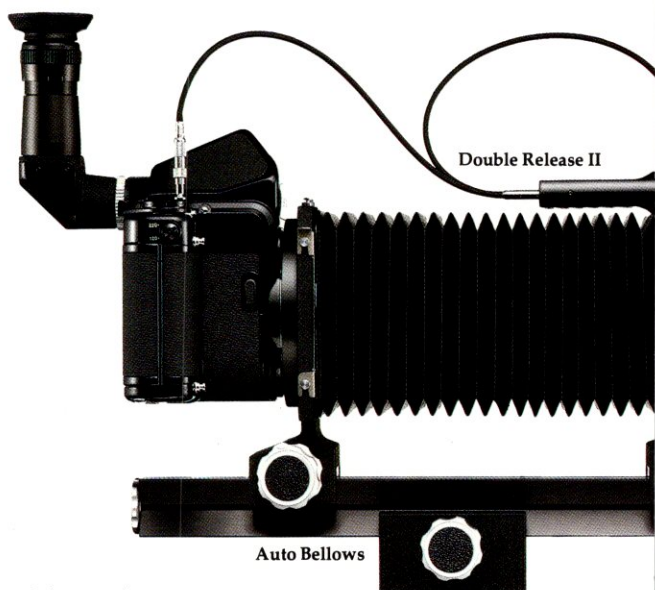

Creativity and Handling

Helicoid Extension Tube: The single extension tube with an internal helicoid mechanism can be used with lenses from 55mm to 200mm to provide continuously variable extension for precise control of the image size. Used with the 105mm f/2.4 standard lens, it offers a magnification ranging from 0.3× to 0.63×.

49mm & 67mm Reverse Adapters: Used to mount lenses with matching filter sizes in reverse onto the Helicoid Extension Tube, Auto Extension Tube or Auto Bellows in macrophotography, these adapters enable the lens to maintain its superb optical performance at greater-than-life-size magnifications.

Slide Holder K: Used to copy 35mm transparencies onto the 6×7-format film, this handy unit offers magnifications up to 2× when combined with a 50mm macro lens from the 35mm SLR system, Helicoid Extension Tube and 49mm Reverse Adapter.

Slide Copier: Used in combination with the Auto Bellows, it makes life-size or partially cropped duplicates of mounted or sleeve transparencies, in either 35mm or 6×7 format.



Auto Extension Tube Set
(No.1, No.2 & No.3)



Extension Tube Set A



Helicoid
Extension Tube



49mm & 67mm
Reverse Adapters



Slide Holder K

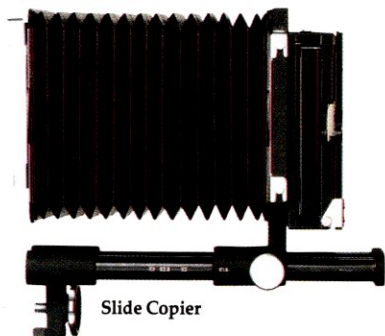

Slide Copier

Right-Angle Finder: Attached to the eyepiece of the standard or TTL pentaprism finder, it presents a laterally correct and unreversed image for low-angle photography. The entire viewfinder image, including the exposure meter needle of the TTL Pentaprism, is clearly visible.

Magnifier: It doubles the image size at the central area of the viewfinder for critical focusing while improving viewing comfort with its built-in diopter. It can be raised out of the way to check the overall composition of the image.

Eyecup: Attached to a pentaprism eyepiece or right-angle finder, it prevents extraneous light from obstructing the view or adversely affecting the TTL exposure meter.

Correction Lenses: Attached to the eyepiece of a standard or TTL pentaprism finder, they correct the view finder image for near- and far-sightedness. Available in seven strengths from -5 to +2.

Double Release II: Used in combination with the Auto Bellows, it enables the Pentax 67 to retain automatic diaphragm operation for clear view and easy focusing at open aperture.

Cable Releases: Used to eliminate camera shake at shutter release and also to lock the shutter for long-time exposures. Available in 30cm and 50cm lengths.

Copy Stand: Structured with two rigid posts, it offers reliable support for copying work and macrophotography in combination with the Pentax 67, Extension Tubes or Auto Bellows.



Remote Control Cord: By keeping the battery warm in a pocket, it solves power supply problems at freezing temperatures that cause the malfunction of the electronic shutter and other mechanisms. It has a battery compartment at one end and a connector to the camera at the other.

Quick-Focusing Rings: They allow easy adjustment of the focusing ring by the left hand without sacrificing a firm grip on the camera. Type "A" for 105mm, 150mm and 200mm lenses and type "B" for 35mm, 45mm, 55mm, 75mm and 95mm lenses.

Grip: Instantly mounted or removed with one hand, this heavy-duty grip provides a firm grip of the camera for stable positioning and easy carrying. It also features an accessory shoe for a flash unit.

Quick Shoe 67/645: With the top section screwed into the camera's tripod socket and the bottom attached to the tripod, it speeds up mounting and removal operation of the camera to and from the tripod.

Lens Filters: Both SMC and conventional filters are available in five screw-in sizes (67mm, 77mm, 82mm, 95mm and 100mm) for the following variations: Skylight, Cloudy, Morning & Evening, UV (ultra-violet), Y2 (yellow), O2 (orange), R2 (red) and YG (yellow-green).

Linear/Circular Polarizing Filters: Used with both B&W and color films, these filters eliminate surface reflection to increase sky contrast without affecting the rest of the picture elements. The linear type is available only in a 67mm size while the circular type comes in 67mm and 77mm sizes.

Gelatin Filter Frames: They accept standard 75mm gelatin filter squares. Available in 67mm, 82mm and 100 sizes.

SMC Pentax PF Filters: Specially designed to protect the front lens element of the M* 400mm f/4 ED[IF] (112mm size) and M* 800mm f/6.7 (128mm size) lenses.



SMC Close-Up Lenses: These lightweight lenses easily screw onto the lens filter threads for low-magnification close-up work, without sacrificing automatic diaphragm operation and open-aperture metering. They can be used jointly with most Pentax filters.

Rear Converters: They extend the focal length of the lens without sacrificing automatic diaphragm operation. The 1.4× model extends the focal length of the lenses from 165mm to 400mm by 1.4 times while the 2× model doubles that of lenses in the 35mm—400mm range (except for the Shift 75mm and 90mm). The T5-1.4× model is for exclusive use with the M* 800mm f/6.7 ED[IF] to extend its focal length by 1.4 times.

Adapter K for 67-System Lenses: Fitting on both the inner and outer bayonets of a 67-System lens, it mounts the lens onto a Pentax 35mm SLR camera body with a K-type (K_A and K_f) mount, which can be used only in stopped-down metering.

Adapter 645 for 67-System Lenses: This mounts a 67-System lens onto a Pentax 645 camera body while retaining automatic diaphragm operation and open-aperture metering.

Lens Hoods: They reduce the amount of stray light striking the lens for improved contrast and color saturation. Available for 45mm, 55mm, 75mm, 90mm, 105mm, 135mm, and 150mm lenses.

Soft Lens Cases: Made of soft buckskin, they protect lenses from 35mm to 200mm.

Hard Lens Cases: Made of top-quality leather and custom-designed for each lens, they provide maximum lens protection.

Professional Trunk Case II: Designed exclusively for the Pentax 67, this rugged aluminum case holds one camera body, three to four lenses and various other accessories.

Carrying Case: Designed compact and lightweight, it holds one camera body with a standard lens and some accessories and provides excellent protection.

Digital Spotmeter: This compact spotmeter features large red LEDs in the viewfinder to ensure maximum visibility regardless of prevailing lighting conditions. It measures an acute 1° angle via an SPD metering cell. Correct exposure is displayed instantly by EV values (rounded off to the closest $1/3$ EV unit) for a range between EV 1 and EV 20 at ISO 100.

Spotmeter V/ Spotmeter V-FL: The Spotmeter V measures an acute angle of 1° for highly accurate reading of primary subjects via a highly sensitive silicon photo diode. Its viewfinder features a scale and pointer with readings given in EV values within a range of EV 1 to EV 19 at ISO 100. The V-FL model offers the same features, except that it indicates exposure information in foot-lamberts and calculates illuminance ratios, making it especially valuable for TV and film metering.



Adapter K for
67-System Lenses



Adapter 645 for
67-System Lenses



Professional Trunk Case II

Digital Spotmeter



Spotmeter V



Pentax 67 Specifications

Type: 6×7 ideal-format single-lens reflex.

Film: 120 roll film (10 exposures) and 220 roll film (20 exposures).

Picture size: 55mm × 70mm (2-1/4" × 2-3/4").

Standard lenses: SMC Pentax 67 90mm f/2.8 or SMC Pentax 67 105mm f/2.4.

Lens mount: Dual bayonet mount (with inner and outer bayonets)

Shutter: Electronically controlled double-curtain focal-plane shutter. 1/1000 sec.—1 sec., X and B.

Viewfinder: Detachable pentaprism finder with microprism focusing screen with 0.85× magnification (with standard lens) and 90% picture area (100% with waist-level finders).

Mirror: Swing-up instant-return mirror with lock-up mechanism.

Film transport: Rapid-wind lever with self-cocking shutter. 180° stroke and 10° stand-off angle.

Exposure counter: Self-resetting exposure counter.

Flash synchronization: FP and X terminals. Electronic flash usable at 1/30 sec.—1 sec. and B.

Exposure meter: Optional TTL Pentaprism Finder with through-the-lens meter coupling with shutter speed and aperture.

Power source: One 6V alkaline or silver-oxide battery.

Dimensions: 177mm (W) × 150mm (H) × 91mm (D) (6.9" × 5.9" × 3.5") with standard pentaprism.

Weight: Body: 1,290g (45.2 oz.). Pentaprism: 460g (16.1 oz.)

Designs and specifications are subject to change without notice.

PENTAX®

Pentax Corporation
Denver Corporate Headquarters & National Service Center
35 Inverness Drive East • Englewood, CO. 80112-5485

New York Sales & Service
1101 Stewart Ave. • Garden City, NY. 11530

Chicago Sales & Service
350 East Devon Ave. • Itasca, IL. 60143

Atlanta Sales & Service
5500 Oakbrook Pkwy, Suite 220 • Norcross, GA. 30093

Los Angeles Sales & Service
8363 Reseda Blvd. • Northridge, CA. 91324

