

Nikon

N4004s

AF

INSTRUCTION MANUAL

CONTENTS

FOREWORD	3	Multi-Sensor vs. Centerweighted Metering	32-35
NOMENCLATURE	4-6	Centerweighted Metering for Special Exposure Situations.....	36-37
BASIC OPERATION	7-15	AEL (Auto Exposure Lock) Button.....	36
MOUNTING THE LENS.....	7	Manual Exposure Mode	37
INSTALLING BATTERIES.....	8	Balanced Fill-Flash Photography with Multi-Sensor Metering System	38-39
CHECKING BATTERY POWER.....	9	FLASH PHOTOGRAPHY	40-44
LOADING FILM.....	10-11	BUILT-IN TTL FLASH	40-41
BASIC SHOOTING.....	12-14	Shooting Dark Subjects.....	40
REWINDING FILM.....	15	Automatic Balanced Fill-Flash Photography	41
FOCUS	16-21	FLASH PHOTOGRAPHY USING EXTERNAL SPEEDLIGHT	42-43
AUTOFOCUS	16-17	SHUTTER SPEED—FLASH MODE COMBI- NATIONS FOR EACH EXPOSURE MODE	44
Taking Pictures with an Off-Center Main Subject.....	16	READY-LIGHT WARNINGS	44
Autofocusing with AF Illuminator	17	SELF-TIMER	45
MANUAL FOCUS WITH ELECTRONIC FOCUSING CONFIRMATION	18	CAMERA CARE TIPS	46-47
MANUAL FOCUS USING CLEAR MATTE FIELD	19	NOTES ON BATTERIES	48
SPECIAL FOCUSING SITUATIONS	20-21	LENSES	49-50
EXPOSURE	22-39	ACCESSORY COMPATIBILITY	51
Shutter Speed Dial and Aperture Dial	22	EXPOSURE VALUE (EV)	52-53
PROGRAM AUTO EXPOSURE MODE	23	GLOSSARY	54-55
SHUTTER-PRIORITY AUTO EXPOSURE MODE	24-25	SPECIFICATIONS	56-58
APERTURE-PRIORITY AUTO EXPOSURE MODE	26-27	VIEWFINDER INFORMATION	59
MANUAL EXPOSURE MODE	28-29		
EXPOSURE METERING SYSTEM	30-39		
Advanced Automatic Exposure Control with Nikon's Exclusive Multi-Sensor Metering System.....	30-31		
Centerweighted Metering.....	31		

FOREWORD

Thank you for purchasing this Nikon product. We hope you enjoy the Nikon N4004s, and we're sure it will make photography a bigger part of your life. For the first time ever, we are incorporating Nikon's exclusive Decision Master System, a complete system that integrates camera and lens computers to give you automatic control of all picture taking operations, and makes the Nikon N4004s an absolute joy to use.

Get to know your N4004s, but before using it, be sure to read this manual thoroughly.

Nikon cannot be held responsible for malfunction resulting from the use of the camera other than as specified in this manual.

Your Nikon camera requires precise electronic and mechanical matching between component products such as lenses and electronic flash. Nikon brand lenses and electronic flash units are made to Nikon's factory specifications and will operate properly and in accordance with the Nikon Limited Warranty that was provided with your products.

Damage to your Nikon product, as a result of malfunction or improper connections, caused by the use of Non-Nikon brand products, **is not covered under the terms of the Nikon Limited Warranty and will void the Nikon warranty.**

NOMENCLATURE

Lens (AF Zoom-Nikkor 35 – 70 mm f/3.3 – 4.5)

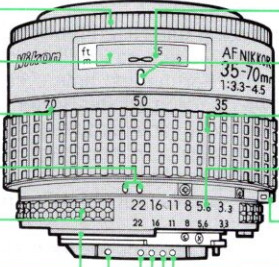
Focusing ring		Distance scale
Distance scale window		Distance/focal length index line
Focal length scale		Zoom ring
Aperture indexes		Aperture scale
Aperture ring		Minimum aperture lock
Meter coupling ridge		AF contacts

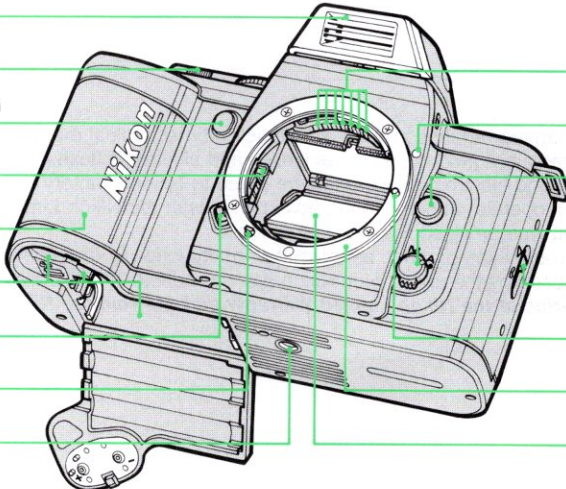
Flash head		AF contacts
Self-timer indicator LED		Lens mounting index
AEL (Auto Exposure Lock) button		Lens release button
Aperture coupling lever		Focus mode selector
Handgrip		Camera back lock release
Battery chamber		Lens release pin
Minimum aperture lever		Lens mounting flange
AF coupling		Reflex mirror
Tripod socket		

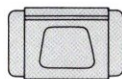

Eyepiece cover DK-5

Flash lock-release buttons

Shutter speed dial

Accessory shoe

Dial lock-release button

Camera strap eyelet

Shutter release button

Self-timer button

Film rewind button

Film plane indicator

Camera strap eyelet

Film cartridge confirmation window

Frame counter

Camera back

Film rewind lever

Film advance indicator

Aperture dial

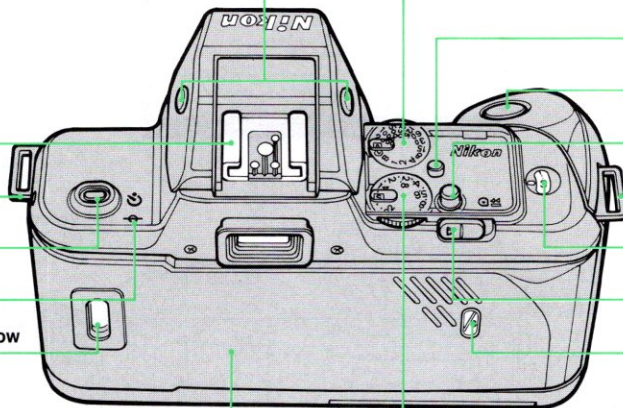

Inside Viewfinder

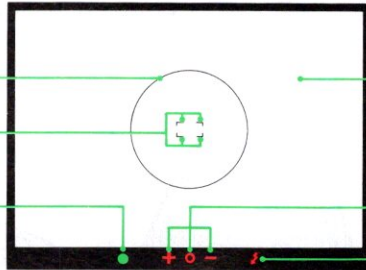

12mm-dia. central area

Clear matte field

Focus brackets

Focus indicator LED

Exposure indicator LEDs

Flash ready-light

Film sprocket

Film take-up spool

Viewfinder eyepiece

Film pressure plate

Film rewind fork

DX contacts

Film cartridge chamber

Film pressure roller

Shutter curtains

Film leader index

Film guide rails

Battery chamber lock release

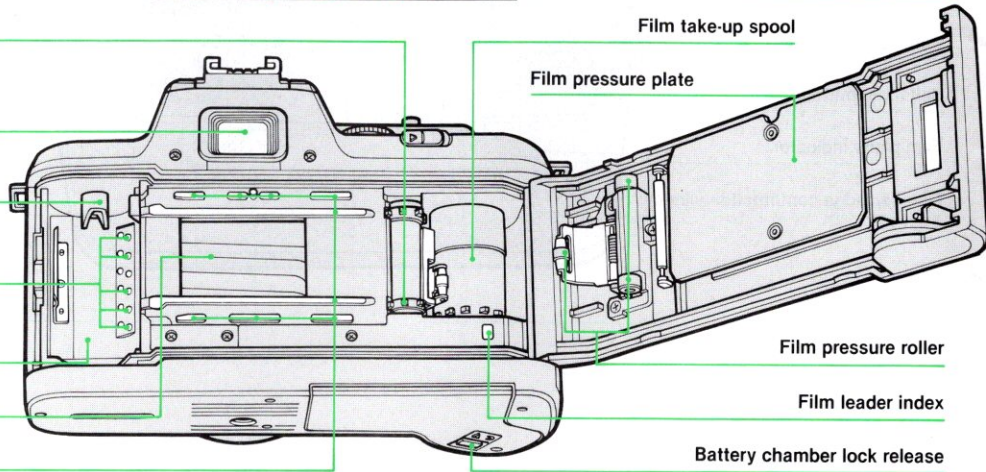

BASIC OPERATION

MOUNTING THE LENS

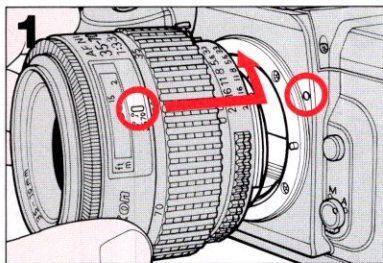

Twist lens counterclockwise until it securely clicks into place.

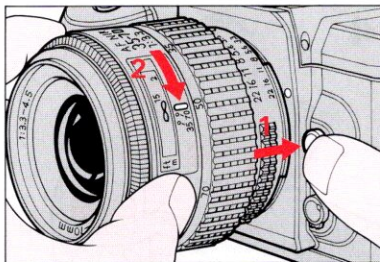

To remove

Do not push lens release button except when removing lens.

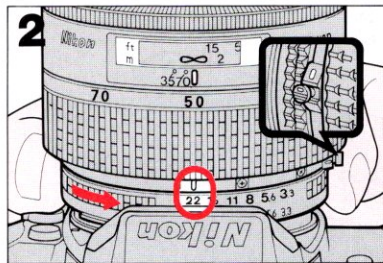

Set lens to its smallest aperture (largest f-number), then turn minimum aperture lock to lock position.

The N4004s is designed for use with AF Nikkor lenses, except AF-Nikkor 80mm f/2.8, 200mm f/3.5 IF-ED, and Autofocus Converter TC-16/TC-16A. For limited use of non-AF Nikkor lenses, see page 49.

With the N4004s, all aperture setting operations are performed using the aperture dial on the camera body. Do not move lens' aperture ring once it is set to its smallest aperture (largest f-number).

INSTALLING BATTERIES

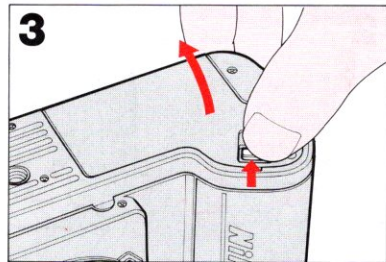

Open the battery chamber lid by sliding the lock release.

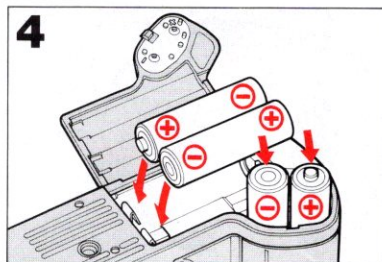

Install four fresh AA-type batteries with “+” and “-” ends positioned as shown inside the battery chamber.

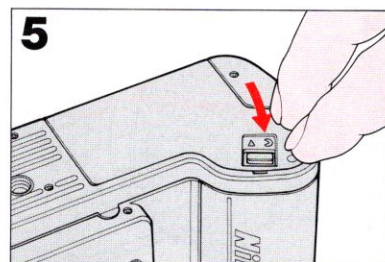

Close the battery chamber lid.

Batteries with a “+” terminal exceeding 6 mm in diameter cannot be used.

CHECKING BATTERY POWER

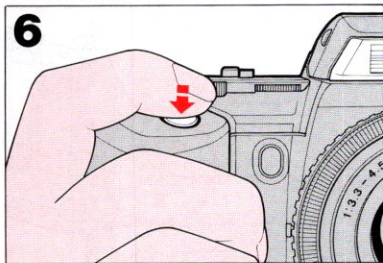

Lightly press shutter release button and check viewfinder exposure indicator LED(s) to make sure battery power is sufficient.

Battery power can also be checked by film advance speed, operation speed of autofocus lens or flash recycling time. When these become noticeably slower, change batteries.

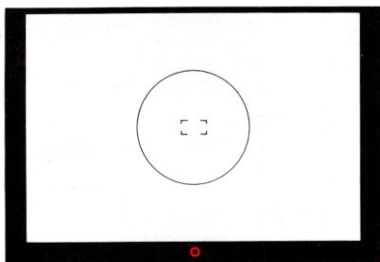

Exposure indicator LED(s) lights up or blinks if power is sufficient, and stays on approx. 8 sec. after you take your finger off the button.

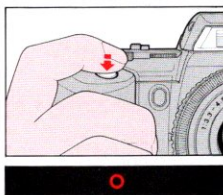

If LED goes off approx. 2 sec. after finger is removed from button, batteries need replacement.

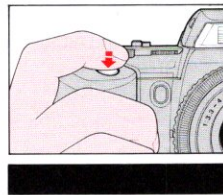
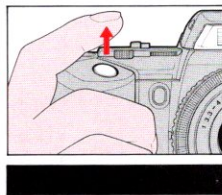

No LED, and shutter locks. Check battery installation or change batteries.

The microcomputer in the N4004s may turn the camera off, even when batteries with sufficient power are properly installed. To start or resume operation, remove batteries and install again.

LOADING FILM

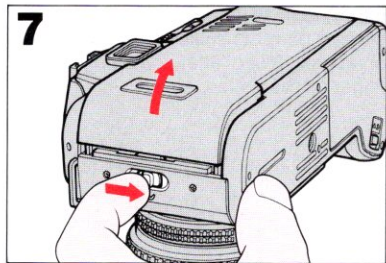

Slide down camera back lock release to open camera back.

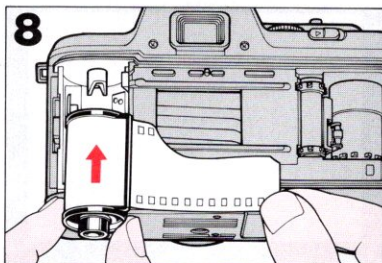

Insert film cartridge.

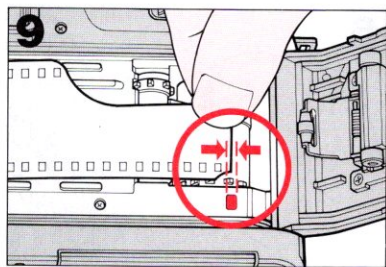

Pull film leader out to red index mark.

- Use only DX-coded film.
- Usable film speed range for DX-coded film is ISO 25 to 5000.
- All non-DX-coded films are automatically set to ISO 100.
- Avoid loading/unloading in direct sunlight.

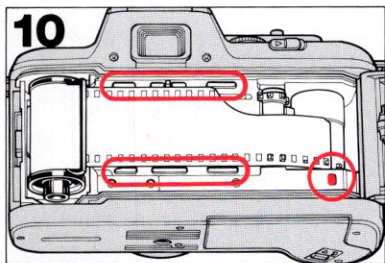

10
Check to make sure film is positioned properly, with no slack.

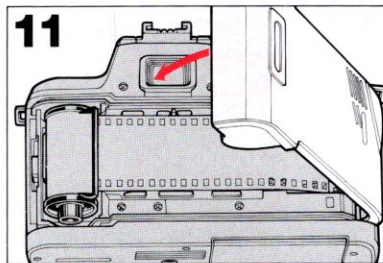

11
Close camera back and confirm lock-release snaps closed.

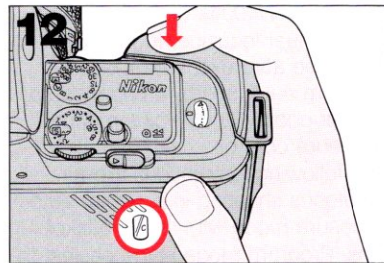

12
Fully depress shutter release button to automatically advance film to frame "1."
Observe film advance indicator rotation to confirm proper film installation and transport.

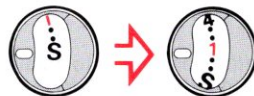
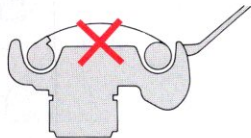
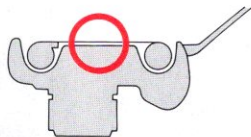

BASIC SHOOTING

The Nikon N4004s offers both auto and manual focusing. It also gives you three auto exposure modes—program auto, aperture-priority auto, shutter-priority auto—plus manual exposure control.

The following instructions are for autofocus shooting in program auto exposure mode with an AF Nikkor lens. Program mode is the easiest to use and most automatic exposure mode.

For details about other focusing methods and exposure modes, see pages 18 to 21 and 24 to 29, respectively.

Confirm lens is set to smallest aperture (largest f-number); if lens is incorrectly set, the shutter release locks and + and – LEDs blink alternately.

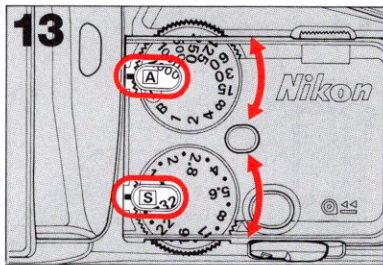

Set shutter speed dial to A, and aperture dial to S.

When both A and S are set, program auto mode is in operation.

The shutter dial locks at the A or L position, and the aperture dial locks at the S position. To release them, rotate the shutter or aperture dial while pressing the dial lock-release button.

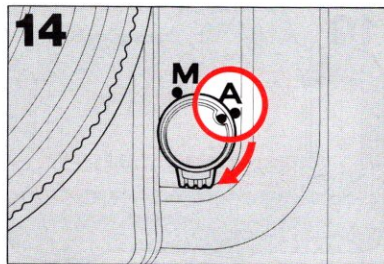

Set focus mode selector to A (autofocus).

If the lens in use has an A-M switch, set the switch to A.

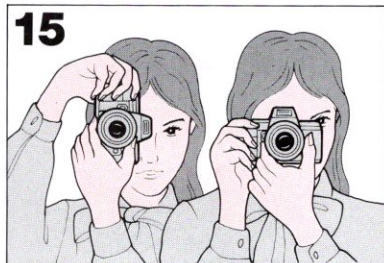

Aim camera at the subject.



Position the viewfinder focus brackets on the main subject.

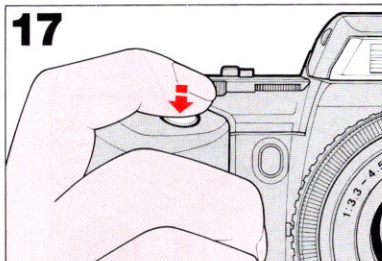

Lightly press the shutter release button.

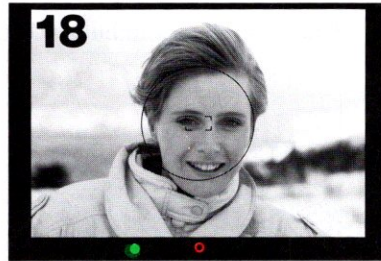

Confirm the green focus indicator LED ● and the red exposure indicator LED ○ light up.

- If focus indicator LED ● blinks, see page 20.
- If subject moves and the focusing distance changes, refocus by briefly removing finger from shutter release button and lightly pressing again to reactivate autofocus function.

- 1) ○ blinks **Picture blur possibility (shutter speed is 1/30 sec. or slower).** Use tripod to avoid camera shake, or use built-in TTL flash or accessory Nikon speedlight to synchronize shutter speed at 1/100 sec.
- 2) + lights up* **Overexposure warning.** Too bright—very rare condition; use film with lower ISO speed.
- 3) - lights up* **Underexposure warning.** Too dark—use built-in flash or accessory Nikon speedlight.
- 4) ⚡ blinks Use built-in TTL flash or accessory Nikon speedlight.

* Shutter is locked.

Flash shooting with built-in TTL flash

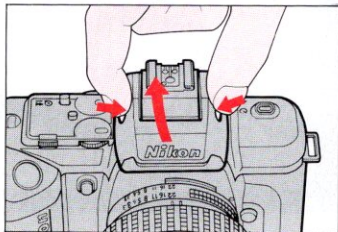

1. Push flash lock release buttons to release built-in flash.

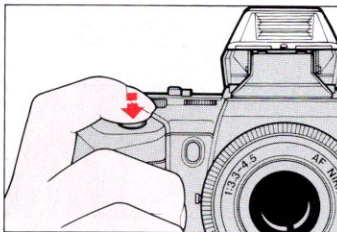

2. Lightly press shutter release button to turn on the N4004s.

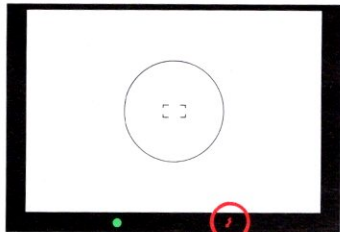

3. Wait a few seconds for ready-light to come on, then shoot.

Check to make sure subject is within proper flash shooting range for film speed in use. If subject is beyond flash shooting range, ready-light LED blinks for approx. 3 sec. after releasing the shutter. For details, see page 40.

19

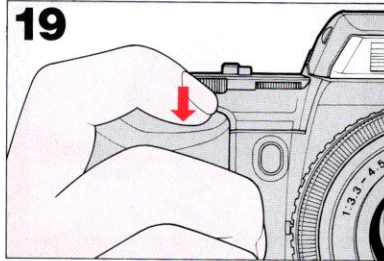

Fully depress shutter release button to take picture. This automatically advances film by one frame.

- Upon shutter release, the exposure indicator LED(s) turns off approx. 2 sec. after you remove your finger from the button.
- If camera detects abnormality during film advance (when film is loaded), the self-timer indicator LED lights up for a few seconds. If this happens, set the shutter speed dial to L (lock), then proceed as usual.

REWINDING FILM

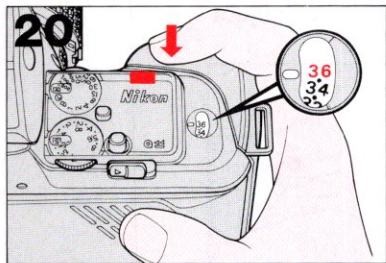

The film advance stops automatically at the end of the roll. Then, the self-timer indicator LED lights up for a few seconds and the shutter locks.

If you do not rewind the film when you come to the end of the roll, each time the shutter release button is depressed, the self-timer indicator LED lights up for a few seconds to remind you to rewind it.

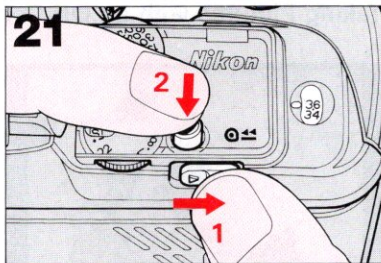

While sliding film rewind lever, push the film rewind button.

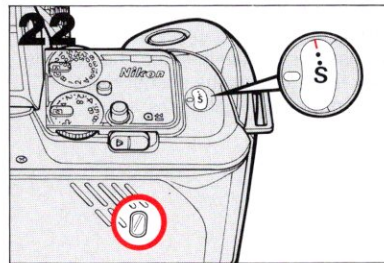

After rewinding stops (automatic), confirm film frame counter has returned to "S".

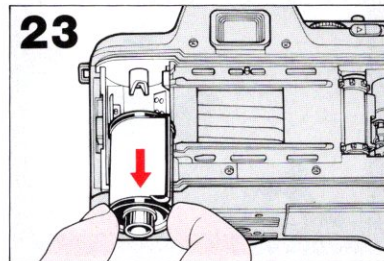

Open camera back and remove film cartridge.

FOCUS

AUTOFOCUS

In autofocus mode, the shutter cannot be released until the subject is correctly focused, and once in focus, the focus is locked as long as the shutter release button remains lightly pressed.

Taking Pictures with an Off-Center Main Subject

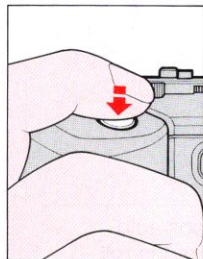
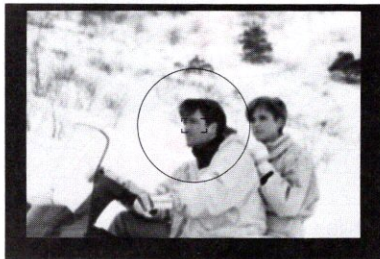

1. Center the focus brackets on the subject and lightly press the shutter release button.

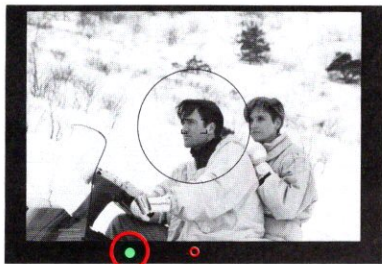

2. Confirm the focus indicator LED lights up.

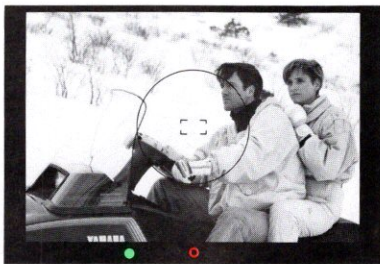

3. Keeping the shutter release button lightly pressed, recompose and fully depress the shutter release button.



Autofocusing with AF Illuminator

If existing light is insufficient for autofocus operation:

1. Mount Nikon Autofocus Speedlight SB-24/SB-23/SB-22/SB-20 on the accessory shoe of the N4004s.
2. Lightly press the shutter release button.
3. The speedlight's AF illuminator lights up to start autofocus operation. For details, see speedlight instruction manual.

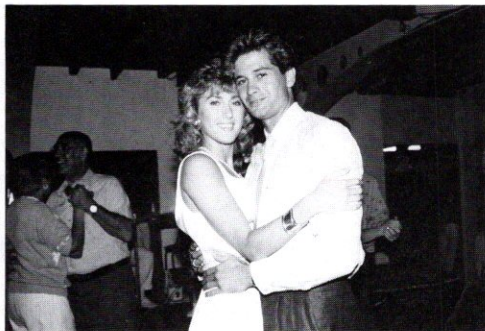
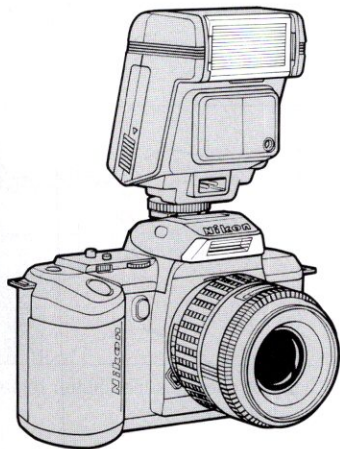

MANUAL FOCUS WITH ELECTRONIC FOCUSING CONFIRMATION

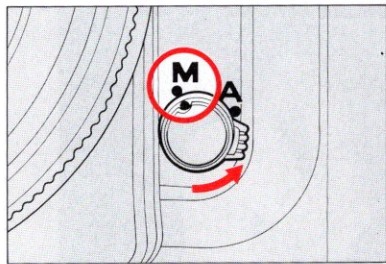

1. Set focus mode selector to M (manual). If the lens in use has an A-M switch, set the switch to M.



2. Look inside viewfinder and center the focus brackets on the main subject.

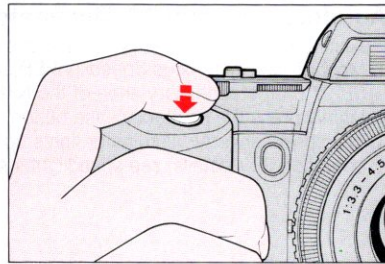

3. Lightly press the shutter release button.



4. Keeping the shutter release button lightly pressed, watch the focus indicator LED in the viewfinder and rotate the lens focusing ring manually until the focus indicator LED lights up.

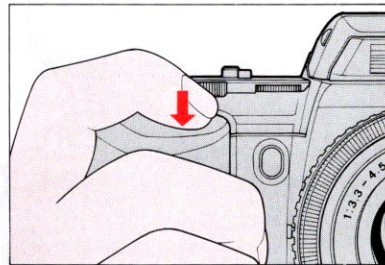
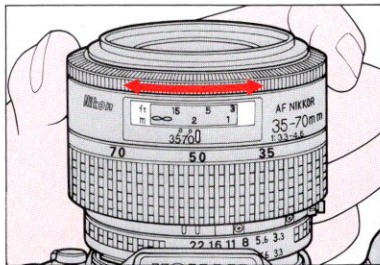

5. Fully depress the shutter release button.

MANUAL FOCUS USING CLEAR MATTE FIELD

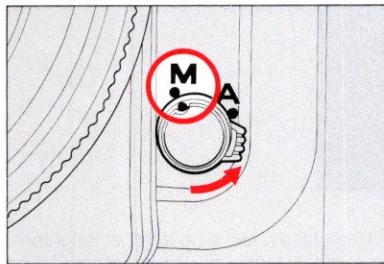

1. Set the focus mode selector to M (manual).



2. Focus subject using the clear matte field.

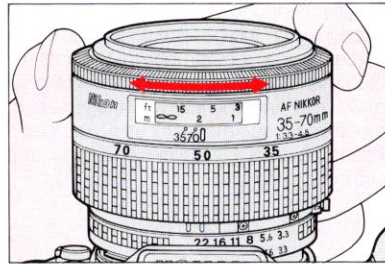

SPECIAL FOCUSING SITUATIONS

Autofocus operation and electronic focusing confirmation depend upon the general lighting of the scene, subject contrast and details, and other technical points. Under certain conditions, the automatic focusing system/electronic focusing confirmation may experience difficulty. In these circumstances, we recommend you focus manually using the clear matte field. Focus indicator LED blinks or disappears with the following subjects:

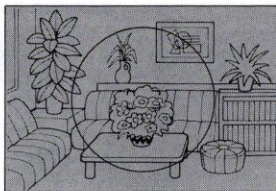

1) Very dark subject

Focus manually, or for autofocus, focus on another, brighter subject located at the same distance, or use accessory Nikon Autofocus Speedlight SB-24, SB-23, SB-22 or SB-20. (No other flash unit can be used.)

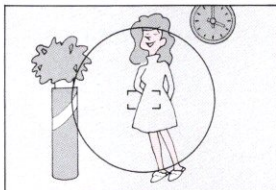

2) Low-contrast subject

Focus manually, or for autofocus, focus on another subject located at the same distance—but with more contrast—until the green focus indicator LED appears.

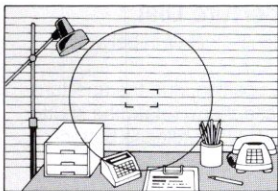

3) Subject with no vertical lines

Turn the camera sideways to focus, or focus manually. You may also select autofocus, then focus on another subject with vertical lines located at the same distance.

In the following situations, ignore focus-indicator LED and focus manually using the clear matte field.

- 1) When shooting the following:
 - Very bright subject with shiny surface, such as silver or aluminum.
 - Strongly backlit subject.
 - Scene with subjects located at different distances.
- 2) When using a polarizing filter. (Circular polarizing filter can be used for autofocus operation.)

EXPOSURE

Exposure control consists of two parts—aperture control and shutter speed control. The aperture works basically the same way as the iris of the human eye and controls the amount of light passing through the lens. The shutter, located in the camera body, varies the amount of light admitted to the film by opening and closing at different speeds. Together, these two controls determine the amount of light that strikes the film, resulting in exposure control.

Using the shutter speed and aperture dials of the N4004s, you can select three different automatic exposure control modes and one manual mode.

Shutter Speed Dial and Aperture Dial

Always set dials at click-stop positions—never in-between.

The shutter dial locks at the A or L position, and the aperture dial locks at the S position. To release them, rotate the shutter or aperture dial while pressing the dial lock-release button.

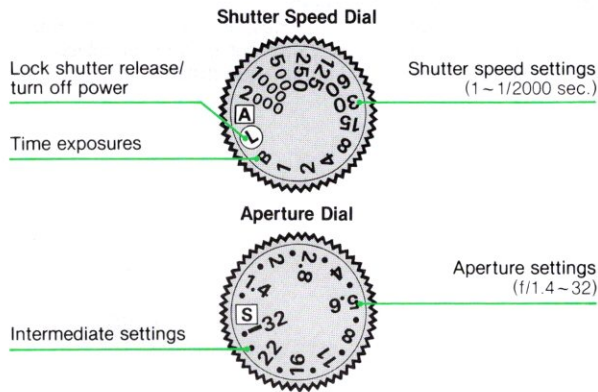

Shutter speed dial	Aperture dial	Exposure mode
A	S	Program auto
1 ~ 2000	S	Shutter-priority auto
A	1.4 ~ 32	Aperture-priority auto
B, 1 ~ 2000	1.4 ~ 32	Manual

PROGRAM AUTO EXPOSURE MODE

Program auto is the easiest exposure mode to use, since it controls both aperture and shutter operation. The microcomputer in the N4004s automatically sets the best combination of shutter speed and lens aperture, and matches these with the correct **dual program** (normal or high speed) for the lens in use. Normal program is selected for lenses with focal lengths shorter than 135mm. High-speed program is selected for lenses with longer focal lengths to reduce the possibility of blurred pictures due to subject movement or camera shake. With zoom lenses, either normal or high-speed program will be selected, depending on the focal length setting.

The EV (Exposure Value) chart demonstrates the difference between normal and high-speed programs of the N4004s. Follow either colored line to where it intersects a diagonal line. This shows the combination of aperture (vertical line) and shutter speed (horizontal line). For example, at a brightness of EV10, the N4004s selects f/2.8 and 1/125 sec. with AF 180mm f/2.8 lens at ISO 100, or f/4 and 1/60 sec. with an AF 50mm f/1.4 lens at ISO 100.

Dual program chart

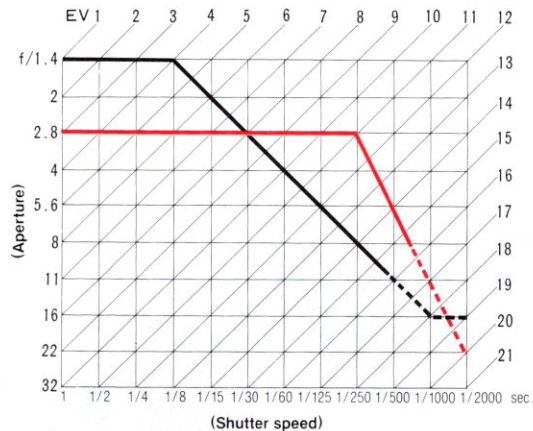

- Normal program (with AF 50mm f/1.4 lens at ISO 100)
- High-speed program (with AF 180mm f/2.8 lens at ISO 100)

SHUTTER-PRIORITY AUTO EXPOSURE MODE

This mode lets you choose shutter speeds manually, so you can freeze the action with sharp, clear outlines using fast shutter speeds, or create motion effects by choosing slower shutter speeds. The microcomputer in the N4004s automatically selects the correct aperture to match the shutter speed you set.



At a fast shutter speed



At a slow shutter speed

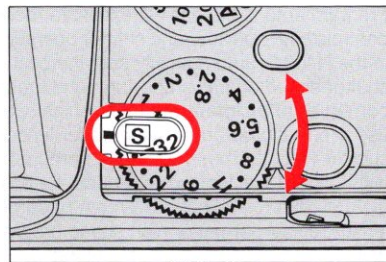

1. Set aperture dial to S.

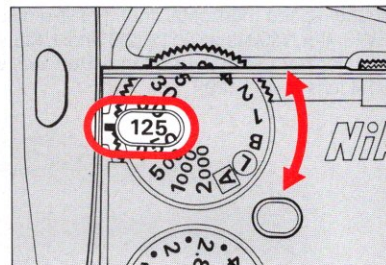

2. Set shutter speed dial to desired speed.

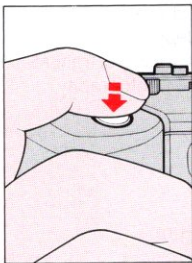

3. Look inside viewfinder and lightly press the shutter release button.

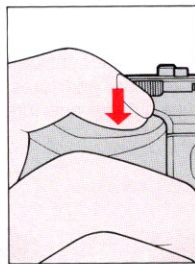

4. When the exposure indicator LED lights up, fully depress the shutter release button.

If exposure indicator LED  does not light up:

+ lights up*	Select a higher shutter speed
- lights up*	Select a slower shutter speed, or use built-in flash or speedlight
+/- blink alternately*	Set lens to its smallest aperture setting
+/- disappear*	Shutter dial is set to "B"; select other position

* Shutter is locked.

APERTURE-PRIORITY EXPOSURE MODE

The microcomputer in the N4004s automatically selects the correct shutter speed to match the aperture you set. This is the recommended mode when depth of field is your prime consideration. To create softer, less distinct backgrounds, as in portraits, use wider apertures. For overall sharp, clear pictures, such as scenic photography, use smaller apertures.



At wide aperture



At small aperture

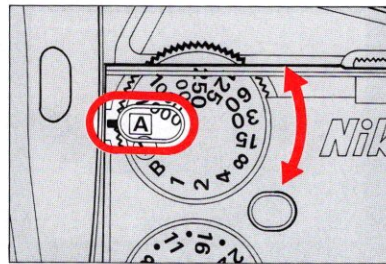

1. Set shutter speed dial to A.

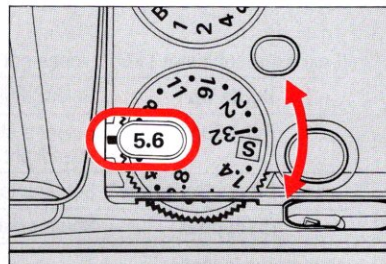

2. Set aperture dial to desired f-number.

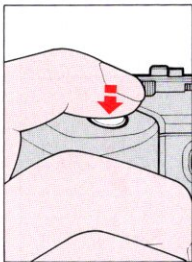
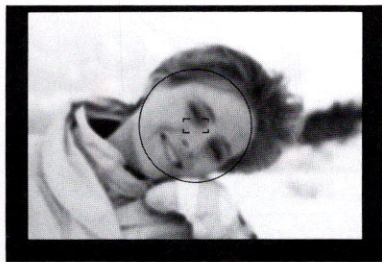



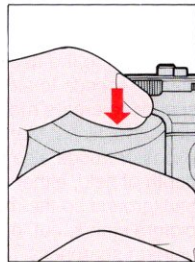

3. Look inside viewfinder and lightly press shutter release button.



4. When the exposure indicator LED lights up, fully depress the shutter release button.

If exposure indicator LED  does not light up:

- | | |
|---|--|
|  blinks | Picture blur possibility (shutter speed is 1/30 sec. or slower). Select faster aperture setting (smaller f-number), or use a tripod to avoid camera shake. |
|  lights up* | Select slower aperture setting (larger f-number) |
|  lights up* | Select a faster aperture setting, or use built-in flash or speedlight. |
|  blink alternately* | Set lens to its smallest aperture setting. |

* Shutter is locked.

If aperture dial is set beyond lens' aperture range, aperture is automatically adjusted to minimum or maximum setting, whichever is nearest, and correct shutter speed is selected accordingly.

MANUAL EXPOSURE MODE

In manual exposure mode, both shutter speed and aperture can be set manually according to the desired effect. Use fast shutter speeds to stop the action, slower speeds to create motion effects or less distinct outlines. Manually setting the exposure mode also lets you control depth of field, either by softening the background so the main subject of the picture stands out, or by creating overall uniform sharpness.

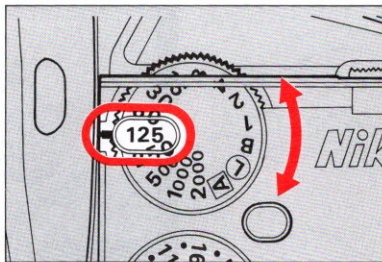

1. Set shutter speed dial to desired speed.

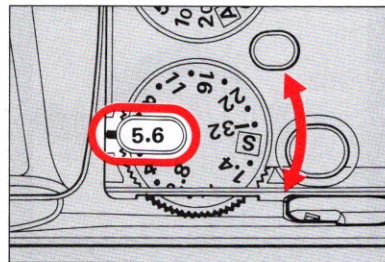

2. Set aperture dial to desired f-number.

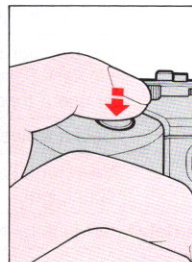
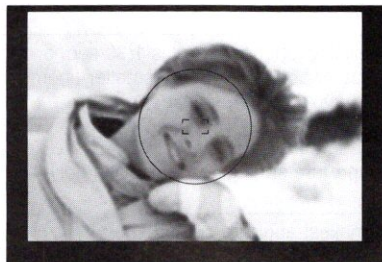

3. With your eye on the viewfinder, lightly press the shutter release button.

Multi-Sensor Vs. Centerweighted Metering

In scenes with both very bright and very dark areas, these two metering systems produce varying results. For example:

1. Scene containing the sun or with high reflectivity

If a scene contains highlights, such as the sun, snow or bright reflections, centerweighted metering renders the main subject as a silhouette. With Nikon's advanced multi-sensor metering, however, the light value of darker parts is evaluated, resulting in an overall well-balanced exposure.

2. Outdoor backlit subject

With centerweighted metering, a backlit subject or scene with people against a bright sky and/or clouds may lead to an underexposed shot. With multi-sensor metering, however, the camera automatically gives more exposure to dark subjects to ensure a correct overall exposure.

3. Front-lit subject against dark background

If a brightly lit off-center subject is positioned against a dark background, centerweighted metering places too much emphasis on the dark center of the picture. So although the background is correctly exposed, the main subject will be overexposed. Multi-sensor metering, however, automatically integrates the dark background with the bright subject to ensure the best overall exposure.

Scene containing the sun



Multi-sensor metering

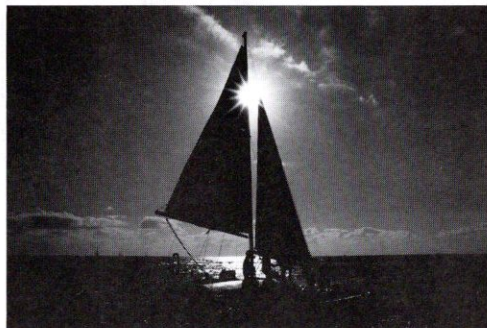

Centerweighted metering

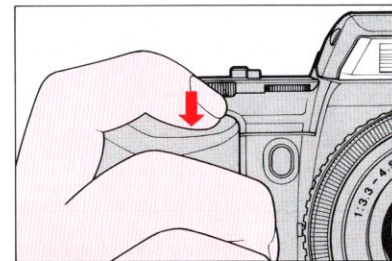
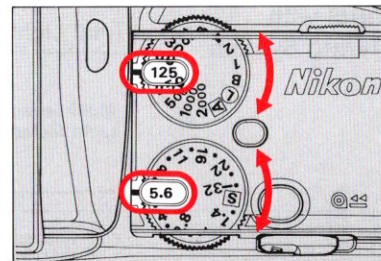

4. Rotate either shutter speed dial or aperture dial until exposure indicator LED lights up.

5. Fully depress the shutter release button.

+ or - LED lights up in the following cases*:

+ Overexposure warning	+1EV ~
+○ Overexposure warning	+1/3EV ~ +1EV
○ Correct exposure	-1/3EV ~ +1/3EV
○- Underexposure warning	-1EV ~ -1/3EV
- Underexposure warning	~1EV

* Shutter does not lock in any of these cases.

If aperture dial is set beyond lens' aperture range, aperture is automatically adjusted to minimum or maximum setting, whichever is nearest.

Outdoor backlit subject



Multi-sensor metering



Centerweighted metering

Front-lit subject



Multi-sensor metering



Centerweighted metering

4. Small dark subjects against a bright background

A subject significantly smaller than any one of the multi-sensor areas may not be recognized and integrated into the automatic exposure evaluation. For such subjects, we recommend you use either the AEL or manual exposure control for center-weighted metering.



Centerweighted metering (w/AEL button)

Main subject is correctly exposed. For details, see page 36.

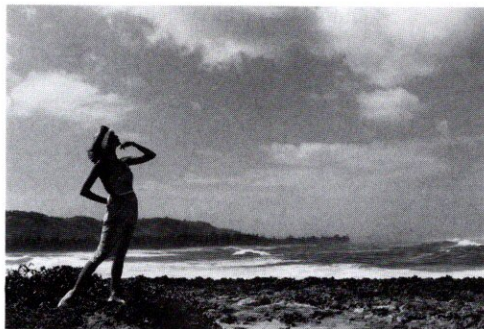

Multi-sensor metering

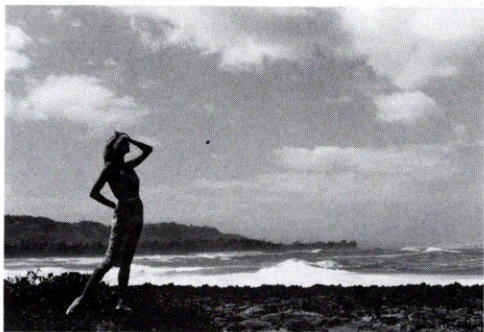

Centerweighted metering (w/o AEL button)

5. Sunset scenes

When you want to emphasize a dramatic sunset, but don't want the Decision Master System to lighten the scene for dark foreground subject, use the AEL or manual exposure control for centerweighted metering.



Multi-sensor metering

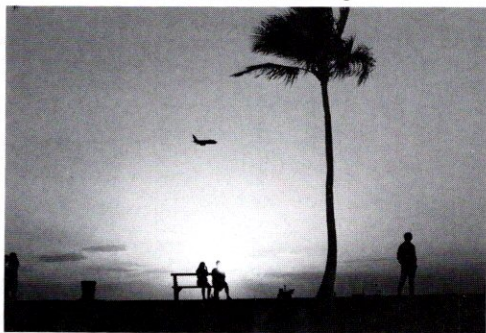

Centerweighted metering

Centerweighted Metering for Special Exposure Situations

AEL (Auto Exposure Lock) Button



1. Center main subject inside viewfinder or move in closer.

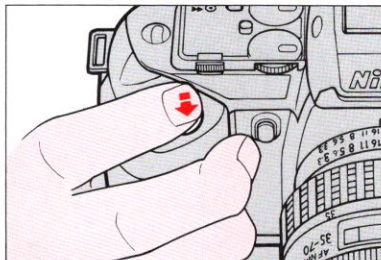

2. Lightly press shutter release button.

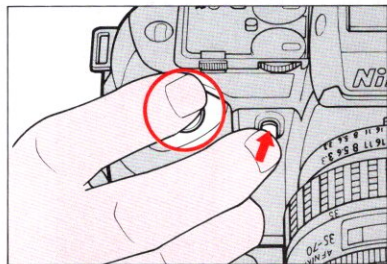

3. While lightly pressing shutter release button, depress the AEL button and hold it in.



4. Recompose and shoot.

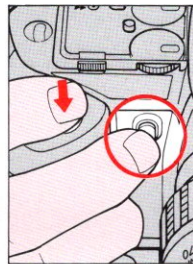

Manual Exposure Mode

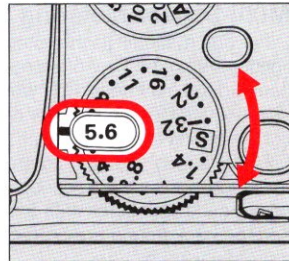
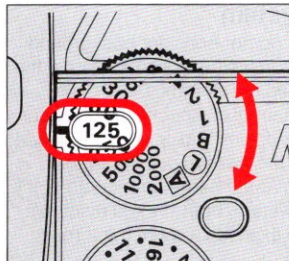
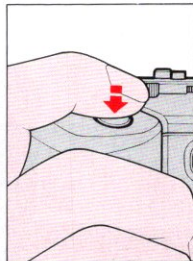
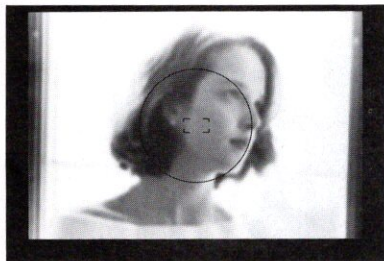

1. Center main subject inside viewfinder, and lightly press the shutter release button.

2. Adjust the shutter speed and aperture for correct exposure.



3. Confirm the exposure indicator LED lights up.



4. Recompose and shoot.

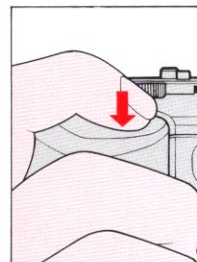

Balanced Fill-Flash Photography with Multi-Sensor Metering System

Other automatic fill-flash systems do not consider background lighting. Although they often result in well exposed subjects, the background may be terribly washed out or dark.

The N4004s Decision Master System uses special multi-sensor light metering to evaluate such conditions and perform "Balanced Fill-Flash." This means it controls the flash exposure so the main subject is well exposed, and at the same time controls the background exposure. With this system, both the main subject and the background are correctly exposed, producing a much more pleasing picture.

To avail yourself of this feature and brighten a subject which might otherwise come out dark due to available light conditions, simply use the Decision Master System's automatic balanced fill-flash capability. This system produces balanced fill-flash when shooting within the flash's normal operating range.

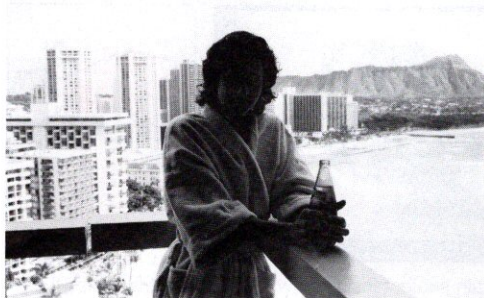

Centerweighted metering

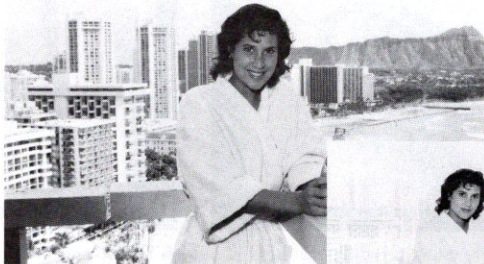

Balanced fill-flash



Conventional fill-flash

Here's how it works. In program, aperture-priority or shutter-priority auto exposure mode, metering system of the N4004s automatically detects situations which benefit from balanced fill-flash and activates the blinking viewfinder ready-light indication to recommend you use the camera's built-in flash or an accessory Nikon speedlight. For automatic balanced fill-flash, **first set the camera in program auto exposure mode**, then follow these procedures:

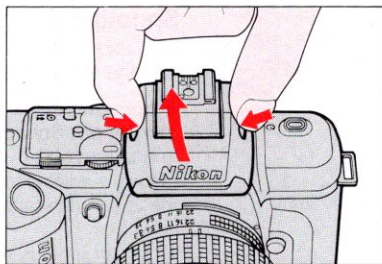

1. Push flash lock-release buttons to release built-in flash.

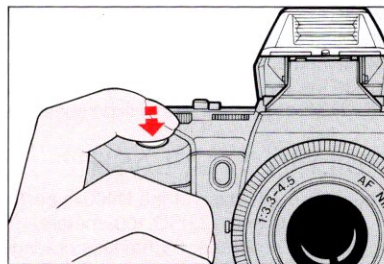

2. Lightly press shutter release button to turn on the N4004s.

Check to make sure the subject is within proper flash shooting range for film speed in use. For details, see pages 40 and 41.

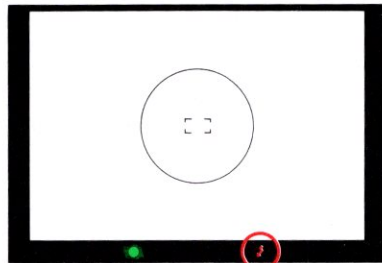

3. Confirm ready-light comes on, and shoot.

FLASH PHOTOGRAPHY

When existing light is insufficient for normal shooting or when shooting a dark subject against a bright background (i.e., subject positioned against a bright window), the ready-light indicator LED inside the viewfinder blinks to indicate you should use the built-in TTL flash or an accessory Nikon speedlight.

BUILT-IN TTL FLASH

The built-in TTL flash of the N4004s performs as follows:

Guide number: 12 (ISO 100, meters)

Angle of coverage: 35mm lens or longer

Usable lenses:

AF 35mm f/2 AF 50mm f/1.4 AF 50mm f/1.8

AF 85mm f/1.8 AF 180mm f/2.8 AF 300mm f/4

AF 24 ~ 50mm f/3.3 ~ 4.5 (focal length 35mm or longer)

AF 28 ~ 85mm f/3.5 ~ 4.5 (focal length 35mm or longer)*

AF 35 ~ 70mm f/2.8** AF 35 ~ 70mm f/3.3 ~ 4.5

AF 35 ~ 105mm f/3.5 ~ 4.5*** AF 35 ~ 135mm f/3.5 ~ 4.5****

AF 70 ~ 210mm f/4 ~ 5.6 AF 75 ~ 300mm f/4.5 ~ 5.6

AF 80 ~ 200mm f/2.8***** AF Micro 55mm f/2.8

*Cannot be used for shooting a subject at 2m or closer at 35mm focal length. Macro focusing is impossible.

**Cannot be used at 50mm or shorter focal length because vignetting occurs.

***Macro focusing is impossible.

****Cannot be used near the closest focusing distance (1.5m) at 35mm focal length because vignetting occurs. Macro focusing is impossible.

*****Cannot be used for shooting a subject at 2m or closer at 80mm focal length.

- Do not use a lens hood; it could cause slight vignetting.
- All lenses above cannot be used at focusing distance shorter than the flash shooting range.

Shooting Dark Subjects

In all exposure modes, with a subject darker than EV10 at ISO 100, the ready-light LED blinks.

Programmed TTL auto flash photography in program and shutter-priority auto exposure modes

In programmed TTL auto flash photography, the N4004s automatically adjusts the shutter speed to 1/100 sec*, and selects the appropriate aperture according to the speed of the film in use (ISO).

*If shutter speed is set to B, or to 1/60 sec. or slower in shutter-priority exposure mode, shutter fires at the speed set, and correct aperture is selected accordingly.

The usable ranges for film speed, aperture and shooting distance in programmed TTL mode are as follows.

ISO	25	50	100	200	400
Aperture	1.4	2	2.8	4	5.6
Shooting Range	Approx. 1.4 ~ 4.2m				

*Ready-light blinks when using film with ISO speed over 400.

**When using a lens with a slower maximum aperture (larger F-number) than the numbers listed above, the aperture will be automatically set to the lens' maximum aperture, thus shortening the shooting range. (i.e., if maximum aperture is f/3.5 and film speed is ISO 100, aperture is set to 3.5 instead of f/2.8). For longer flash shooting distances (up to 4.2m), use film with a speed of ISO 400.

TTL auto flash photography in aperture-priority auto and manual exposure modes

In aperture-priority auto mode, the N4004s automatically adjusts the shutter speed to 1/100 sec. In manual mode, when

shutter speed dial is set at from 1/125 to 1/2000 sec., the shutter is automatically set to 1/100 sec., and if set below 1/60 sec., the shutter operates at the speed set. To perform TTL auto flash photography, set the camera's aperture dial to the correct aperture for flash-to-subject distance and depth of field.

Usable apertures/shooting distance range in TTL mode

	ISO film speed					Shooting distance range (m)
	400	200	100	50	25	
f/stop	2	—	—	—	—	4 ~ 12
	2.8	2	—	—	—	2.8 ~ 8.5
	4	2.8	2	—	—	2 ~ 6
	5.6	4	2.8	2	—	1.4 ~ 4.2
	8	5.6	4	2.8	2	1 ~ 3
	11	8	5.6	4	2.8	0.7 ~ 2.1
	16	11	8	5.6	4	0.6 ~ 1.5
	22	16	11	8	5.6	0.6 ~ 1.1
	—	22	16	11	8	0.6 ~ 0.8

The maximum shooting distance is estimated by guide number:

$$\frac{\text{Guide Number (GN)}}{\text{Full Aperture}} = \text{Maximum shooting distance}$$

i.e., f/3.5 lens at ISO 100, Guide Number 12:

$$\frac{12}{3.5} = 3.4\text{m}$$

Automatic Balanced Fill-Flash Photography

In program, aperture-priority or shutter-priority auto exposure mode, when shooting a scene with a brightness of EV10 or higher (at ISO 100) where the subject in the central area of the triple sensor is darker than other areas by more than approx. 1.5EV, the ready-light LED blinks to tell you to use built-in TTL flash or accessory Nikon speedlight for fill-in lighting.

For automatic balanced fill-flash photography, first set the camera in **program auto exposure mode** so correct aperture is automatically selected for the scene's background, using a synchronized camera shutter speed of 1/100 sec. The multi-sensor meter of the N4004s measures contrast and brightness for both subject and background, and automatically adjusts speedlight output so you get good overall pictures without complicated techniques.

Maximum shooting distance for balanced fill-flash photography

Near a window	Approx. 3m
Normal outdoor shot	Approx. 2m
Scene containing the sun	Approx. 1.5m

- For scenes where the sun, a shining sea or a bright sky covers a large part of the background, the camera automatically selects smaller apertures, and because the power of the built-in flash is limited, the results may be insufficient. If the ready-light blinks after shooting, move closer to the main subject or use an external speedlight with a larger guide number.
- With scenes where the background is extremely bright, the ready-light may not blink after the shot, even if the flash is insufficient for correct exposure.

FLASH PHOTOGRAPHY USING EXTERNAL SPEEDLIGHT

The accessory shoe of the N4004s enables you to directly mount Nikon dedicated electronic flash (speedlights). Nikon Speedlights SB-24, SB-23, SB-22, SB-20, SB-15, SB-16B or SB-18, enable you to use **programmed TTL auto mode** in program or shutter-priority auto exposure mode. In aperture-priority auto or manual mode, you can use **TTL automatic mode**. Automatic balanced fill-flash is also possible with external speedlight.

An external speedlight cannot be used when the built-in speedlight of the N4004s is turned on. (They cannot be used simultaneously.)

- For details on speedlight operation, see instruction manual for speedlight.
- Use Nikon Speedlights. Other units may damage the camera's electrical circuit due to incompatible voltage requirements.

Nikon N4004s/Speedlight Unit Combination Chart

Nikon Speedlight	Connection	Usable Flash Mode
SB-24* SB-22* SB-20* SB-15 SB-16B	Direct	Programmed TTL auto, TTL auto, non-TTL auto, manual
SB-23*	Direct	Programmed TTL auto, TTL auto, manual
SB-19	Direct	Non-TTL auto
SB-17 SB-16A	Via flash unit coupler AS-6	Non-TTL auto, manual
SB-11 SB-14 SB-140**	Via SC-13 Sensor Remote Cord or AS-15 Hot-Shoe Adapter	Non-TTL auto, manual
SB-21A/21B	Direct	Manual
Medical-Nikkor 120mm f/4 IF	Via 3-pin sync cord SC-22 (provided)	Guide number system

* Autofocus flash photography possible.

** For ultraviolet or infrared photography, use manual mode.

The following instructions are for programmed TTL auto and TTL auto flash shooting only.

- Usable film speed range for TTL flash photography is ISO 25 to 400.* Ready-light blinks when film speed is beyond ISO 400.
- The AF illuminator on the SB-24, SB-23, SB-22 and SB-20 enables the N4004s to perform autofocus operation even in total darkness.
- For non-TTL auto or manual flash shooting with external speedlight, set camera to either aperture-priority auto or manual exposure mode. If camera is set to program or shutter-priority auto mode, aperture cannot be set manually, and the shutter locks.

* ISO 25 to 1600 for non-TTL and manual flash photography.

The usable ranges for film speed and aperture in TTL mode are as follows:

ISO	25	50	100	200	400
Aperture	2.8	4	5.6	8	11

Programmed TTL Auto Flash Photography

In this mode, the camera automatically selects the correct programmed aperture for the film speed in use.

1. Set the N4004s to program or shutter-priority auto exposure mode.
2. Set the speedlight's mode selector to "TTL".
3. Turn speedlight on.
4. Compose and lightly press the shutter release button.
5. Confirm the following viewfinder information, and shoot.
Focus indicator LED Lights up (autofocus mode).
Ready-light LED lights up.

TTL Auto Flash Photography

1. Set the N4004s to aperture-priority auto or manual exposure mode.
2. Set the speedlight's mode selector to "TTL".
3. Turn speedlight on.
4. Select appropriate aperture referring to speedlight's indication, and set the aperture dial.
5. Lightly press the shutter release button to turn on the camera.
6. Confirm ready-light lights up, and shoot.

SHUTTER SPEED—FLASH MODE COMBINATIONS FOR EACH EXPOSURE MODE

Exposure mode	Aperture dial	Shutter dial	Shutter speed setting	Auto flash mode
Program auto	S	A	1/100*	Programmed TTL auto (auto aperture setting)
Shutter-priority auto	S	1/125 ~ 1/2000	1/100*	
		B. 1 ~ 1/60	as set	
Aperture-priority auto	1.4 ~ 32	A	1/100*	TTL auto (manual aperture setting)
Manual	1.4 ~ 32	1/125 ~ 1/2000	1/100*	
		B. 1 ~ 1/60	as set	



*Automatically set by camera.

The above chart applies to both built-in TTL flash and external speedlights.

READY-LIGHT WARNINGS

When using the built-in TTL flash or accessory Nikon speedlights, the ready-light LED in the viewfinder of the N4004s lights up when the flash is recycled. The following ready-light indications are used for warnings:

Before shooting

 disappears	Recharging (with built-in flash, shutter locks; does not lock with external speedlight)
 blinks	Beyond acceptable film speed range for TTL photography (over ISO 400) SB-19's camera selector is set to B or B (EM)*
 lights up	External speedlight not set to TTL*

*For details, see page 59.

After shot

 blinks (approx. 3 sec.)	Light may be insufficient for correct exposure; confirm shooting distance range
--	---

SELF-TIMER

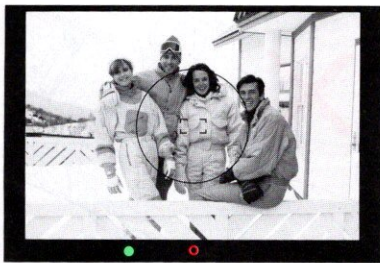

1. Compose picture and confirm focus and exposure.

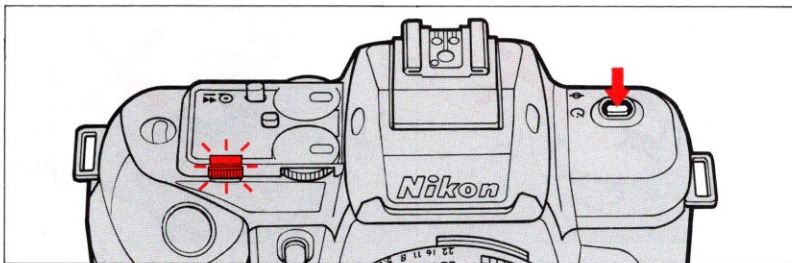

2. Press self-timer button. Self-timer indicator LED starts blinking and shutter is released after approx. 10 sec. For final two seconds, the LED lights up.

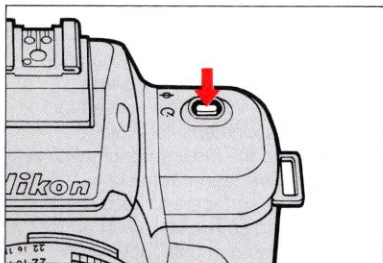

3. To cancel self-timer after activating, press button again.

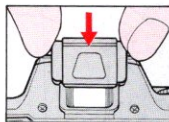

In program, shutter-priority, or aperture-priority auto exposure mode, use eyepiece cover DK-5 to prevent stray light from entering the viewfinder.

In self-timer operation, the shutter is released whether subject is in focus or not. To assure focused image, focus the subject before pressing the self-timer button.

CAMERA CARE TIPS

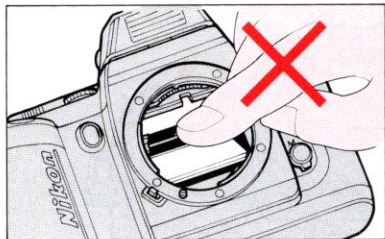

1. Never touch the reflex mirror, focusing screen or AF contacts. Remove dust with a blower brush.

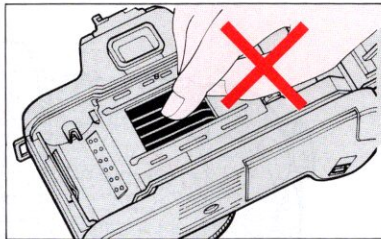

2. Never touch the shutter curtains.

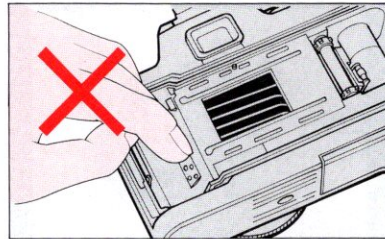

3. Never touch the DX-contacts. Keep clean with blower brush.

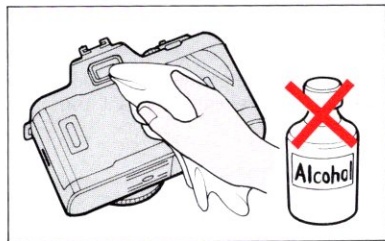

7. Clean the viewfinder eyepiece with a soft, clean cloth. Do not use alcohol.

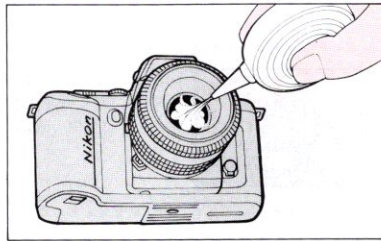

8. Clean glass surfaces such as the lens with a blower brush; avoid using lens tissue as much as possible. To remove dirt and smudges, use soft cotton moistened with pure alcohol and wipe

in a spiral motion from center to periphery. Be careful not to leave traces.

Caution

A spray gun-type blower may damage the glass if used to clean the lens, especially when ED glass is used for the front lens element. To avoid damage, hold the blower upright with its nozzle more than 30cm (12 in.) from the lens surface and keep the nozzle moving so the stream of air is not concentrated in one spot.

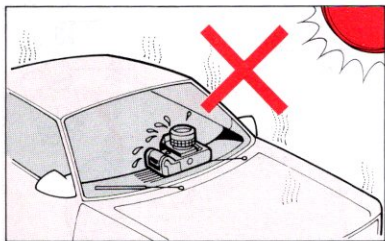

4. Do not leave the camera in an excessively hot place.

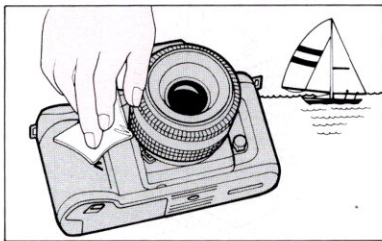

5. If the camera is exposed to rain or mist, or after shooting near the sea, wipe with a clean, soft cloth.

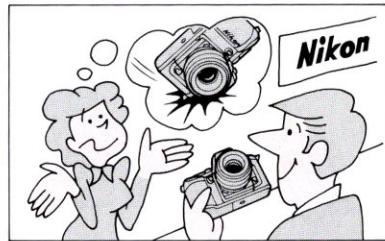

6. If the camera malfunctions, take it immediately to an authorized Nikon dealer or service center.

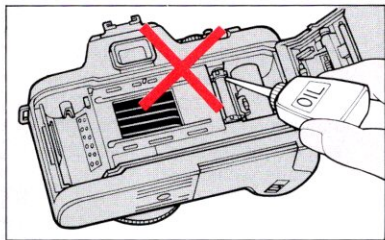

9. Do not lubricate the camera.

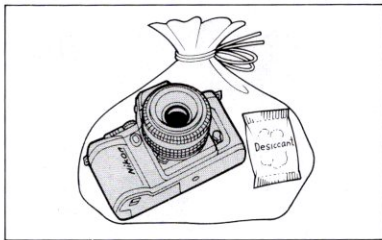

10. Store the camera in a cool, dry place away from naphthalene or camphor (moth repellents). In a humid environment, store the camera inside a vinyl bag with a

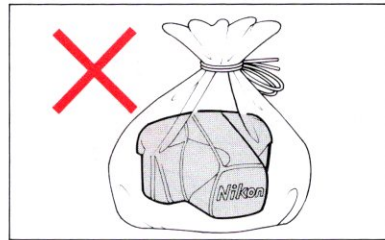

- desiccant to keep out dust, moisture and salt. Note, however, that storing the leather case in a vinyl bag may cause the leather to deteriorate.

NOTES ON BATTERIES

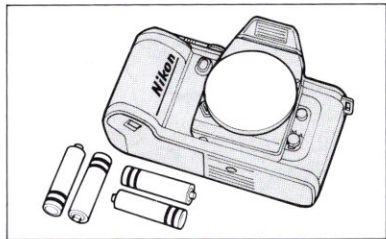

1. When not using the camera for a long period, remove batteries.

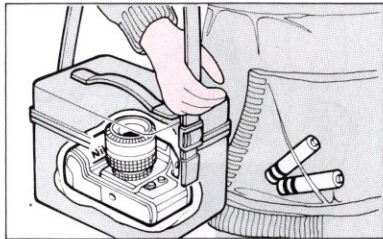

2. Battery power falls off in extremely cold temperatures—make sure batteries are new and keep the camera body wrapped in something warm.

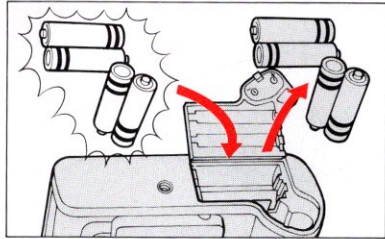

3. When replacing batteries, be sure to replace all batteries at the same time. Always use fresh batteries of the same brand.

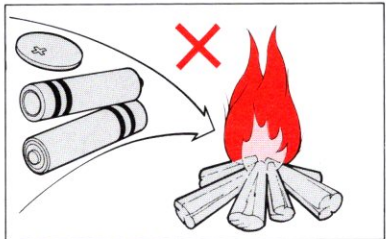

4. Do not throw used batteries into a fire.

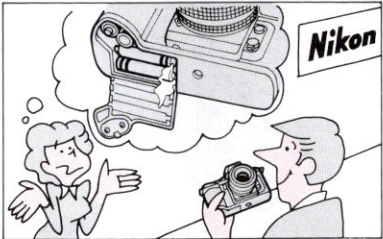

5. If the battery chamber is contaminated by battery leakage, take the camera to an authorized Nikon dealer.

Compared with regular batteries, NiCd batteries provide greater efficiency at low temperatures. Before charging NiCd batteries, thoroughly read the instructions for batteries and battery charger.

LENSES

Nikon N4004s is designed for autofocus photography with AF Nikkor lenses (except AF-Nikkor lenses for F3AF). To take full advantage of N4004s convenience, it is recommended that you should use AF Nikkor lenses.

However, the following lenses can be used with the Nikon N4004s for manual focusing and manual exposure control, in line with the conditions listed at right.

Mountable non-AF Nikkor lenses

AI-P Nikkor lenses

All AI-type Nikkor lenses (including AI-S and AI-modified)

Nikon Series E lenses

Reflex Nikkor lenses 500mm f/8

1000mm f/11 (No. 142360 or smaller,
or No. 143001 or larger)

2000mm f/11 (No. 200311 or larger)

PC-Nikkor lenses

28mm f/3.5

28mm f/4 (No. 180901 or larger)

35mm f/2.8 (No. 851000 or smaller,
or No. 906201 or larger)

Medical-Nikkor 120mm f/4

Teleconverters (except TC-16/TC-16A; they cannot be mounted)

Use of other lenses may damage the camera.

When mountable non-AF Nikkor lenses are used:

- * Exposure indicator LEDs do not appear. Use external exposure meter, then set the exposure using lens aperture ring and shutter speed dial. Ignore the aperture set on camera's aperture dial.
- * If the shutter speed dial is set to L or A, or the aperture dial is set to S, the shutter locks.
- * TTL auto flash is possible with built-in TTL flash or accessory Nikon Speedlights SB-24, SB-23, SB-22, SB-20, SB-15, SB-16B. (Programmed TTL auto flash is not possible.) To use flash or speedlight, set shutter speed dial to 1/60 sec. or slower, then set the aperture using the lens aperture ring. For speedlight settings and shooting distance range, see speedlight instruction manual. Except for flash recommendation, ready-light functions as normal. Fill-flash cannot be controlled automatically.
- * When using the N4004s with an AI-P Nikkor lens, automatic exposure control is available but automatic focusing is not.

Lens Compatibility

	Focusing			Exposure Control			
	Autofocus	Manual w/electronic focusing confirmation	Manual	Program auto	Shutter-priority auto	Aperture-priority auto	Manual
AF Nikkor lenses (except AF Nikkor lenses for F3AF)	○	○	○	○	○	○	○
AI-P Nikkor lens	×	△ ¹⁾	○	○	○	○	○
AI-type Nikkor lenses	×	△ ¹⁾	○	Camera's exposure meter does not operate and exposure indicator LEDs do not appear. Set exposure using the lens aperture ring and camera's shutter speed dial			
Series E lenses	×	○	○				
Reflex Nikkor lenses ⁴⁾	×	×	○				
PC-Nikkor lenses ⁴⁾	×	△ ²⁾	○				
Medical-Nikkor 120mm f/4	×	○	○				
Teleconverters (except TC-16/TC-16A)	×	△ ³⁾	○				

- 1) With maximum aperture of f/5.6 or faster.
- 2) Unless lenses are **shifted**.
- 3) With maximum effective aperture of f/5.6 or faster.
- 4) Some lenses cannot be used.

ACCESSORY COMPATIBILITY

The following accessories cannot be used with the Nikon N4004s.

- * Cords that connect to sync terminal
- * Accessories that connect to remote terminal
- * Cable releases
- * Neckstrap AN-1 (leather)
- * Others:
 - PF-1 ~ 3, PH-3, PB-2, PK-1 ~ 3, PN-1, K-2, BR-2
 - Accessories exclusively designed for other cameras
- If accessories such as close-up attachments are mounted directly on the lens mount of the N4004s, exposure indicator LEDs do not appear. Set aperture using lens aperture ring.
- Filters with a large exposure factor may affect the camera's multi-sensor metering. Use centerweighted metering (AEL button or manual exposure mode).

- Programmed TTL auto flash and TTL auto flash, including automatic balanced fill-flash, are not possible with SB-21, SB-11, SB-14 or SB-140—even with a TTL remote cord or TTL multi-flash sync cord.
- PK-1, PK-11, BR-4 and K-1 Rings cannot be mounted directly on AF Nikkor lenses.
- Polarizing filters cannot be used for autofocus or auto exposure; use a circular polarizing filter.
- Special filters, such as soft focus filters, cannot be used for autofocus or for manual focus with electronic focusing confirmation.

EXPOSURE VALUE (EV)

Exposure consists of shutter control and aperture control. The N4004s offers a range of speeds from 1/2000 second to 1 second, with each setting twice as fast as the next slower speed. Faster speeds allow less light to pass; slower speeds admit more light.

Aperture control enables you to vary the lens aperture opening from large to small, with larger apertures allowing more light to pass, and smaller apertures allowing less light to pass.

The standard aperture settings are f1.4, f2, f2.8, f4, f5.6, f8, f11, f16, f22, f32, etc.

For simplicity, shutter/aperture gradations are uniform. A change in shutter speed from 1/125 to 1/250 second, for example, reduces the light by 1/2. Similarly, changing aperture from f4 to f5.6 reduces the light by 1/2. Each film used has a particular sensitivity to light, indicated by the ISO number shown on the film cartridge. To achieve the correct exposure for any particular light value, the camera's Image Master Control adjusts the shutter speed and aperture control so just the right amount of light reaches the film to produce the correct exposure. That amount of light is referred to as the Exposure Value or EV and is assigned a number such as EV10, EV15, etc. The brighter the light, the higher the EV number.

Each EV number can be applied to a variety of shutter and aperture combinations. If the correct exposure is 1/125 f5.6, for example, a setting of 1/250 f4 would produce the same exposure. The same EV number would represent both settings.

The preceding explanation should help you understand the charts found in different parts of this manual. But don't worry about the details—the Decision Master System of the N4004s takes care of all calculations and automatically sets the exposure control. This information is provided only for your reference and a fuller understanding of photography.

EV chart with 50mm f/1.4 lens

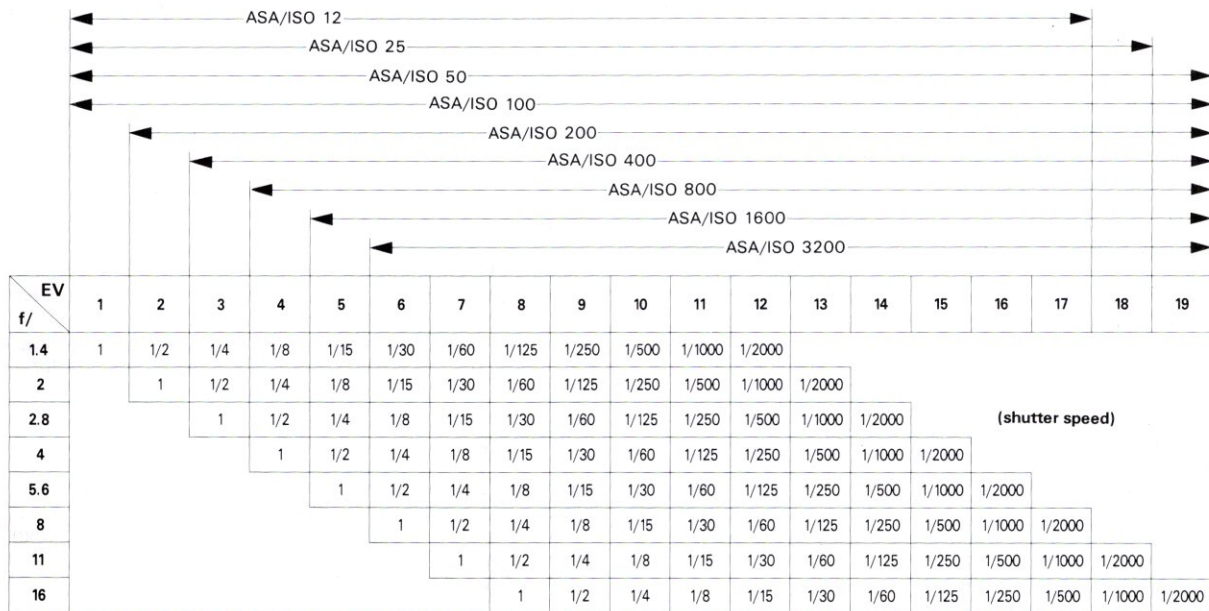

GLOSSARY

AEL (Auto Exposure Lock): AEL is recommended for shooting small dark subjects against a bright background or for shooting dramatic sunset scenes. When AEL is used in program, shutter-priority or aperture-priority auto exposure mode, camera automatically switches to centerweighted metering.

AF illuminator: When existing light is below a certain level and the camera is set for autofocus mode, the SB-24/SB-23/SB-22/SB-20's AF illuminator turns on automatically and provides enough subject contrast to enable the N4004s autofocus system to function as though it were daytime.

Centrewighted metering: In manual mode, or when the AEL button is used in auto exposure modes, the camera automatically switches to centrewighted metering. This secondary metering system places special emphasis on brightness within the 12mm-diameter central area of the viewfinder, making the N4004s exceptionally versatile for a wide variety of subjects.

Decision Master System: Nikon's exclusive optoelectronic system integrates camera and lens computers to provide full automatic control of all camera and lens operations, from autofocus to auto exposure, built-in TTL flash, built-in motor drive, DX film setting, film loading and power rewind. It even automatically carries out such advanced techniques as exposure compensation and balanced fill-flash.

Depth of field: The zone of acceptable sharpness in front of and behind the subject on which the lens is focused. Depth of field can be increased by using small apertures (large f-numbers) or short focal-length lenses, or by taking the picture from farther away. To reduce depth of field use large apertures (small f-numbers), long focal-length lenses, and/or near subjects.

DX-code: Film information code printed on the film cartridge. The N4004s automatically senses the film speed (ISO 25 to 5000) of DX-coded film the instant film is loaded.

EV system: See page 52 and 53.

Balanced fill-flash: Subjects lit from behind or near a window normally appear too dark in photographs, so it is recommended you use a flash for fill-in lighting. Although conventional automatic fill-flash system often result in well-exposed subjects, the background may be washed out of dark. The Decision Master System of the N4004s performs balanced fill-flash with the multi-sensor metering, so both subject and background are correctly exposed, to produce a well-balanced picture.

f-number: Number which indicates brightness of film plane image. The f-number series is 1.4, 2, 2.8, 4, 5.6, 8, 11, 16, 22, 32, etc. Changing one step to the next largest number (i.e., from f11 to f16) decreases image brightness by 1/2; moving to next lower number doubles brightness.

Guide numbers: The number given to a flashbulb or electronic speedlight unit to indicate its power. A guide number may be quoted in meters or feet, and depends on the speed of the film being used. Quoted guide numbers assume a relatively efficient reflector surrounding the flash source, in an average-sized room.

ISO: The international standard for representing film sensitivity (speed with which it reacts to light). The ISO film speed scale is arithmetical, with a film speed of ISO200 being twice as fast as ISO100, and half the speed of ISO400 film.

LED: Abbreviation of Light-Emitting Diode. Used to provide indications inside the camera viewfinder.

Multi-sensor metering: Nikon's exclusive metering system. Drawing on its rich experience of auto exposure technology, Nikon has incorporated a unique multi-sensor light meter into the N4004s. The multi sensor provides additional information to Decision Master System by dividing the scene into three areas to instantly and automatically gauge brightness and contrast. This enables the N4004s to handle all kinds of lighting situations, including high-contrast or backlit scenes, or scenes with a bright sun in the picture.

TTL: Abbreviation of Through-The-Lens. Most SLR cameras have built-in meters which measure light after it has passed through the lens, a feature that enables exposure readings to be taken from the actual image about to be recorded on film, whatever the lens' angle of view and regardless of whether a filter is used.

TTL auto flash mode: In this mode, the camera's light sensor measures flash light, as reflected by the subject on the film, and shuts off the flash when measurement indicates correct exposure. Because the sensor that controls the flash receives light through the lens, this mode can be used for bounce photography, fill-in flash, multiple flash photography, etc. The major advantage of this mode is that you can use a wide range of aperture settings that will give correct exposure.

SPECIFICATIONS

Type of camera	Integral-motor autofocus 35mm single-lens reflex with built-in TTL flash	Exposure metering	Multi-sensor metering (for ensuring correct automatic operation in program, shutter-priority and aperture-priority modes); Centerweighted exposure measurement (for manual exposure mode or when using the AEL button in program, shutter-priority or aperture-priority auto exposure mode)
Picture format	24mm x 36mm (standard 35mm film format)	Exposure meter switch	Activated by lightly pressing shutter release button; stays on for approx. 8sec. after lifting finger from button
Lens mount	Nikon bayonet mount	Metering range	EV1 ~ EV19 at ISO 100 with f/1.4 lens
Lens	AF Nikkor lenses (except AF-Nikkor 80mm f/2.8, 200mm f/3.5 IF-ED, and autofocus converter TC-16/TC-16A), and non-AF Nikkor lenses (with limitation) available	Exposure modes	Program auto, shutter-priority auto, aperture-priority auto and manual exposure modes
Focus modes	Autofocus, and manual focus with focusing confirmation	Program auto exposure control	Normal or high-speed programs automatically selected; both shutter speed and aperture are set automatically
Autofocus		Shutter-priority auto exposure control	Aperture automatically selected to match manually set shutter speed
Autofocus detection system	TTL phase detection system using Nikon Advanced AM 200 sensor	Aperture-priority auto exposure control	Shutter speed automatically selected to match manually set aperture
Autofocus detection range	Approx. EV -1 to EV17 (at ISO 100)	Manual exposure control	Both aperture and shutter speed are set manually
Autofocus actuation method	Single servo	Shutter	Electronically controlled vertical-travel focal-plane shutter
Autofocus lock	Possible	Shutter release	Electromagnetic
Focusing confirmation	Available in manual focus mode with an AF Nikkor, mountable Nikkor and Series E lens with a maximum aperture of f/5.6 or faster.		

Shutter speeds	Stepless speeds from 1/2000 to 1 sec. on program auto and aperture-priority auto; lithium niobate oscillator-controlled discrete speeds from 1/2000 to 1 sec. on shutter-priority auto and manual; electronically controlled long exposure at B setting	Film loading	Film automatically advances to frame 1 when shutter release button is depressed once; film advance indicator rotates to show that film is loaded and being advanced properly
Viewfinder	Fixed eyelevel pentaprism type: 0.8x magnification with 50mm lens set at infinity; 92% frame coverage	Film advance	Film automatically advances one frame at approx. 0.4 seconds when shutter is released; film advance stops automatically at end of film roll
Eyepiece cover	Model DK-5 prevents stray light from entering viewfinder	Frame counter	Accumulative type: automatically reset when camera back is opened
Focusing screen	Nikon new BriteView screen with central focus brackets for autofocus operation	Film rewind	Automatically rewound by built-in motor
Viewfinder information	Green focus indicator LED for focusing, red exposure indicator LED shows over- and underexposure warning, and correct exposure; red flash ready-light for flash photography	Self-timer	Electronically controlled; approx. 10 sec. exposure delay; blinking LED indicates self-timer operation; cancellable
Auto exposure lock	Available via pressing the AEL button while the meter is on (centrewighted metering selected when the AEL button is pressed)	Reflex mirror	Automatic, instant-return type
Film speed range	ISO 25 to 5000 for DX-coded film	Camera back	Hinged back; film cartridge confirmation window and film advance indicator
Film speed setting	Automatically set by DX-coded film (ISO 100 is automatically set for all non-DX-coded films)	Accessory shoe	Standard ISO-type with hot-shoe contact, ready-light contact, TTL flash contact, monitor contact
		Built-in TTL flash	Guide number: 12 (at ISO 100, 20°C and meters); angle of coverage: 35mm lens or longer; programmed TTL auto flash is possible in program and shutter-priority auto modes; TTL auto flash is possible in aperture-priority auto and manual modes

Flash synchronization Automatically set to 1/100sec. in program auto or aperture-priority auto mode, or when shutter is set to 1/125sec. or faster in shutter-priority auto or manual mode; if shutter speed is set to B, or 1/60sec. or slower in shutter-priority auto or manual mode, shutter fires at speed set.

Flash indication Flash ready-light blinks when flash is recommended (scene darker than EV10 at ISO 100, or a scene with brightness of EV10 or higher at ISO 100 where the center portion is darker than other areas by more than 1EV) and lights up when built-in TTL flash or accessory Nikon speedlight is ready to fire

Autofocus flash photography Possible only with Nikon Autofocus Speedlight SB-24, SB-23, SB-22 and SB-20

Power source Four AA-type batteries

Number of 36-exposure film rolls per set of fresh batteries (approx.)

For Autofocus operation with AF Nikkor lens covering the full range from infinity (∞) to the closest distance and back to infinity (∞) before each shot

Batteries	With AF Nikkor 35-70mm f/3.3-4.5 or 50mm f/1.8			
	Without flash		With 50% flash	
	at 68°F	at 14°F	at 68°F	at 14°F
AA-type Alkaline-manganese (LR06)	50	8	20	5
NiCd (KR-AA)	16	15	7	4
Zinc-carbon (SUM-3)	20	1	8	—

Dimensions 154(W) × 102(H) × 65.5(D)mm
[6.1(W) × 4.0(H) × 2.6(D) in.]

Weight (body only) Approx. 650g (22.9 oz.)

Specifications and designs are subject to change without notice.

VIEWFINDER INFORMATION

Exposure mode		Program auto	Shutter-priority auto	Aperture-priority auto	Manual
Focus indicator LED	● lights up	In focus			
	● blinks	Autofocus impossible			
	● disappears	Rear/front focus (shutter does not lock in manual focusing)			
Exposure indicator LEDs	○ lights up	Correct exposure			
	○ blinks	Camera shake warning	—	Camera shake warning	—
	+ lights up	Too bright for auto exposure			Over (+1EV ~)
	- lights up	Too dark for auto exposure			Under (~ -EV)
	+ - blink alternately	Lens aperture not set to minimum			
	+ ○ light up	—			Over (+1 ~ +1/3EV)
	○ - light up	—			Under (-1/3 ~ -1EV)
Ready-light LED	⚡ blinks (before shooting)	Flash recommended (when built-in flash or external speedlight is OFF)			
		Beyond acceptable film speed range for TTL photography (over ISO400)			
		SB-19 is set to B or B (EM)		SB-19 is set to B or B (EM)	
	⚡ disappears	Recharging (shutter does not lock with external speedlight)			
	⚡ lights up	Recharged			
		External speedlight not set to TTL		External speedlight not set to TTL	
⚡ blinks (after shot)	Insufficient light for correct exposure				

 Shutter is locked

No reproduction in any form of this manual, in whole or in part (except for brief quotation in critical articles or reviews), may be made without written authorization from NIKON CORPORATION.

Nikon

NIKON CORPORATION

FUJI BLDG., 2-3, MARUNOUCHI 3-CHOME, CHIYODA-KU, TOKYO 100, JAPAN

PHONE: 81-3-214-5311 **TELEX:** J22601 (NIKON) **FAX:** 81-3-201-5856

Printed in Japan 9&100-BO04