



MINOLTA

E INSTRUCTION MANUAL

---

**MAXXUM<sup>®</sup>**

---

***5000i***

Your new Maxxum 5000i is the world's most compact AF SLR camera with built-in flash. You can rely on it to deliver sharply focused, correctly exposed pictures, roll after roll. Among the camera's outstanding features are:

- Intelligent autofocus that responds at very low light levels, incorporates a wide focus area for easier framing, and uses Predictive Focus Control to capture moving subjects in sharp focus. A built-in, automatically activated AF illuminator enables the autofocus system to keep working in low light, low contrast situations.
- Intelligent exposure, using a dual-area metering system coupled to the autofocus system
- Built-in, automatically controlled zoom flash (guide number 46 to 52 in feet)
- Automatic film transport that makes film handling completely reliable
- Accepts Creative Expansion Cards and the full range of Maxxum AF lenses

We know you want to begin using your new camera right away. Before starting though, please read through this manual; doing so will enable you to take full advantage of your Maxxum 5000i.

## TABLE OF CONTENTS

IMPORTANT INFORMATION . . . . .	2
SUMMARY OF OPERATION . . . . .	3
NAMES OF PARTS . . . . .	4

### GETTING STARTED

#### PREPARATION

Attaching and removing the lens . . . . .	8
Power	
Loading the battery . . . . .	10
Battery-condition indicator . . . . .	11
Cold-weather operation . . . . .	12
Battery performance . . . . .	12

#### Film

Automatic film-speed setting . . . . .	13
Loading film . . . . .	13

#### BASIC OPERATION

Holding the camera . . . . .	16
Shutter-release button . . . . .	17
Taking a picture (using autofocus and autoexposure) . . . . .	18
Film rewind . . . . .	20

### OPERATION IN DETAIL

#### FOCUS

Autofocus . . . . .	22
Focus hold . . . . .	24
Special focusing situations . . . . .	25
Manual focus . . . . .	26

#### EXPOSURE

Program exposure mode . . . . .	28
Autoexposure lock (AEL) . . . . .	29
Manual exposure mode . . . . .	30
Creative camera control . . . . .	32

#### FLASH

Using flash . . . . .	34
Program-mode flash operation . . . . .	36
Slow-shutter sync . . . . .	36
Manual-mode flash operation . . . . .	38

#### ADDITIONAL INFORMATION

Main switch . . . . .	40
Audible signals . . . . .	40
Self-timer . . . . .	41
Long exposures . . . . .	42
Attaching the neckstrap and eyepiece cap . . . . .	44

#### TROUBLESHOOTING . . . . . 46 |

#### ACCESSORIES . . . . . 48 |

#### TECHNICAL DETAILS . . . . . 56 |

#### CARE AND STORAGE . . . . . 59 |

## IMPORTANT INFORMATION

The Minolta Maxxum 5000i camera is designed to offer innovative functions and performance through the combination of camera body, Maxxum AF lenses, Maxxum Flash units, and other accessories distributed by Minolta. We thus caution users that the attachment or use of incompatible lenses, flashes and accessories may result in unsatisfactory performance or damage to the Minolta Maxxum 5000i camera. To obtain optimum performance throughout the life of your Minolta Maxxum 5000i camera, we recommend that you use only lenses, flashes and other accessories distributed or licensed by Minolta for the Maxxum 5000i.

## SUMMARY OF OPERATION

Basic operation of your Maxxum 5000i is very easy.

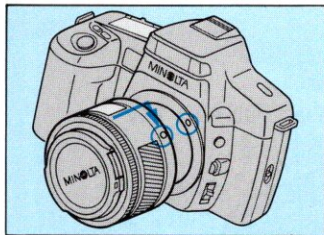

1. Attach lens (p. 8)

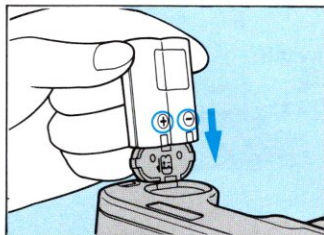

2. Insert battery (p. 10)

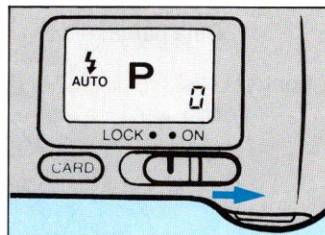

3. Move main switch to ON (p. 40)

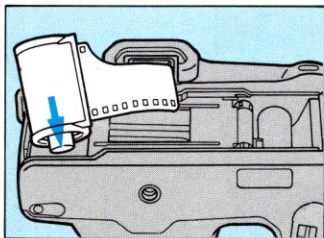

4. Load film (p. 13)

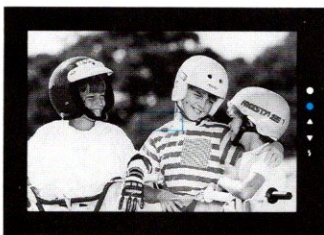

5. Press shutter-release button partway down to focus (p. 18)

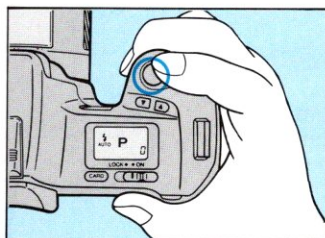

6. Press shutter-release button the way down to take the picture (p. 18)

For a complete description of operation, refer to the pages shown in parentheses.

## NAMES OF PARTS

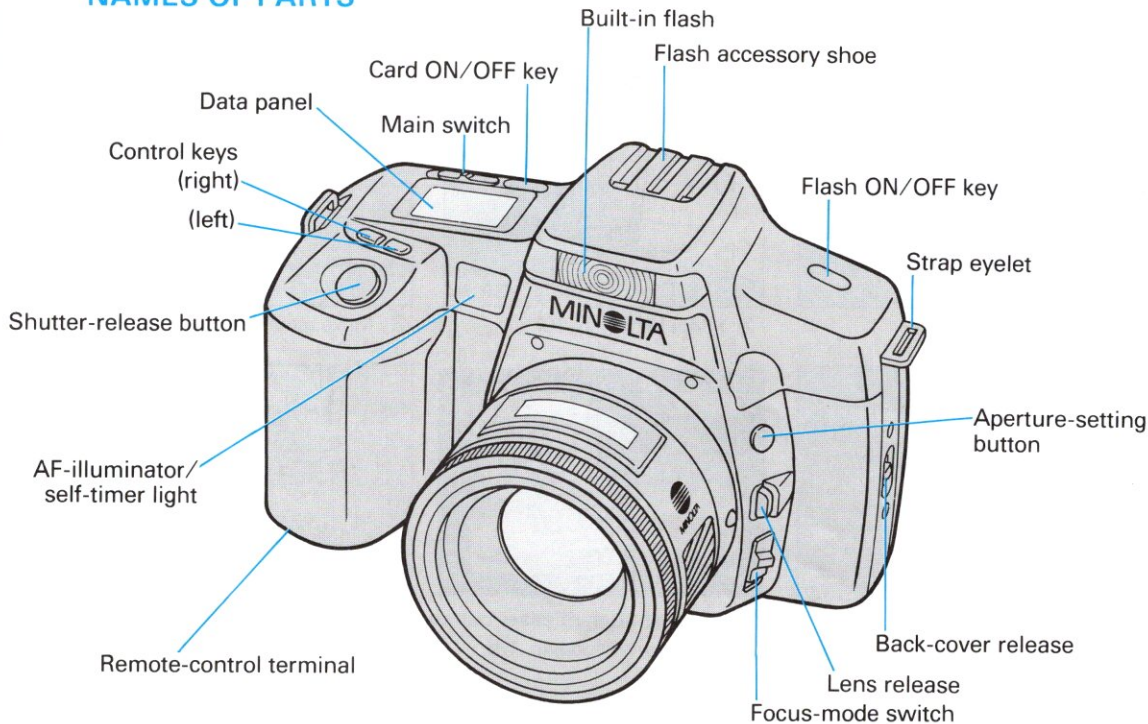

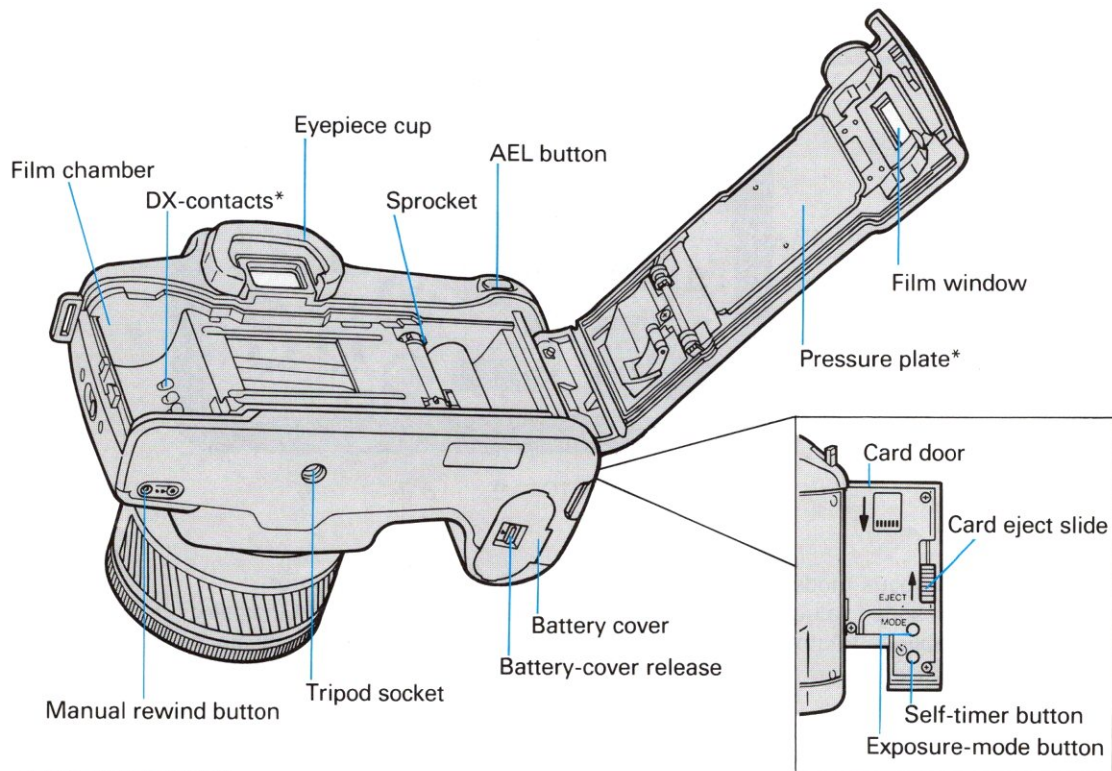

**\* DO NOT TOUCH**

## DATA PANEL

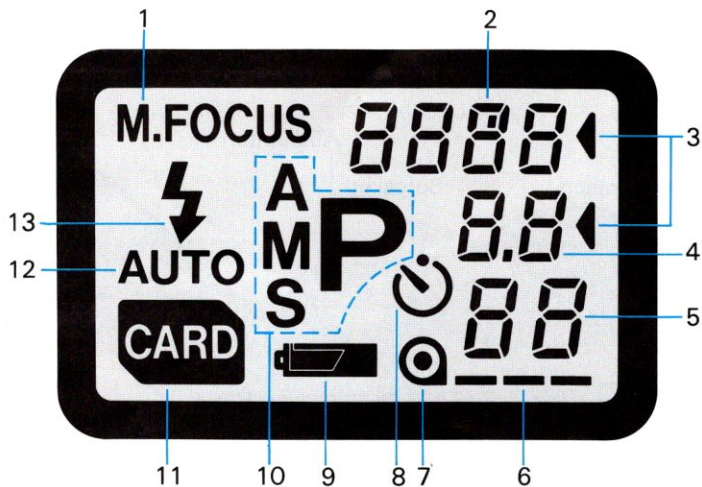

1. Manual-focus-mode indicator
2. Shutter-speed value/card name/HELP
3. Selectable-setting pointers
4. Aperture value
5. Frame counter
6. Film-transport signals
7. Film-cartridge symbol

8. Self-timer indicator
9. Battery-condition indicator
10. Exposure-mode indicator
11. Card-in-use indicator
12. Auto flash indicator
13. Flash-on indicator

## VIEWFINDER

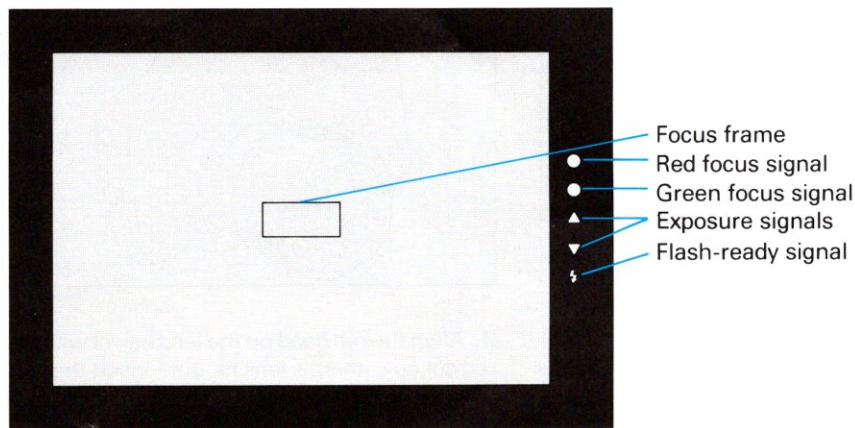

**Focus frame:** Shows image area read by the autofocus system

**Red focus signal:** Blinks when focus cannot be confirmed by the camera's autofocus system.

**Green focus signal:** Glows when focus is set.

**Exposure signals:** In P mode: the lower signal blinks in low-light or backlight situations to indicate that flash should be used. In M mode: the upper and lower signals glow separately or together to indicate over-/under- exposure or cor-

rect exposure, respectively. In both P and M modes: with the flash switched on, the lower signal blinks while the flash is charging; the upper and lower signal blink simultaneously when the required exposure setting is not available.

**Flash-ready signal:** Blinks slowly when the flash is charged, then rapidly after the picture is taken if exposure is correct.

## ATTACHING AND REMOVING THE LENS

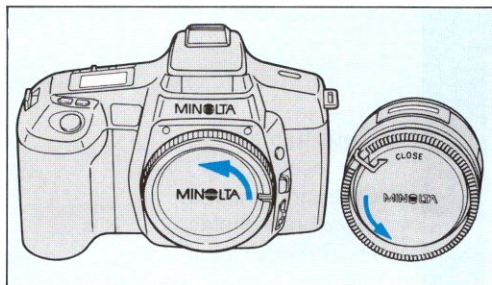

To attach:

1. Remove the body cap and rear lens cap, as shown.

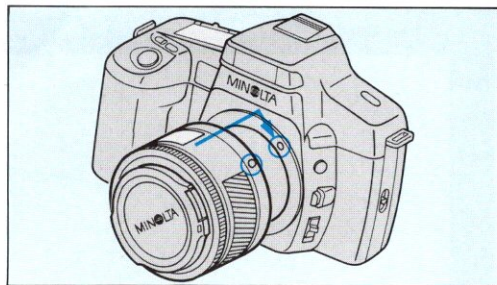

2. Align the red bead on the lens barrel with the red dot on camera's lens mount. Insert the lens bayonet into the mount and turn the lens clockwise until it locks in place with a click.

When attaching or removing lenses, be careful not to touch anything inside the camera, especially the lens contacts or mirror. To protect the lens contacts and elements, attach the lens caps whenever the lens is not in use.

If lens is not attached properly, -- appears in the data panel's aperture display when camera is switched on.

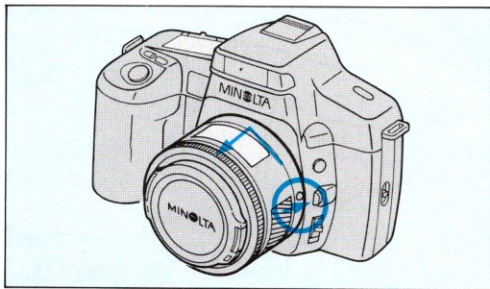

To remove:

1. While pressing the lens release, turn the lens counterclockwise as far as it will go, then lift the lens out.
2. Attach another lens or the body cap to prevent dust from entering the camera.

#### Care of Glass Surfaces

- Never touch lens elements or the camera's eyepiece with your fingers. If the lens becomes dirty, clean it gently with a lens brush. Only if necessary, moisten a sheet of lens tissue with one drop of lens-cleaning fluid and, starting at the center and using a circular motion, lightly wipe the surface of the lens.
- Never lift the mirror or touch its surface, since this may impair its alignment. Dust specks on the mirror's surface will not effect exposure or picture quality. If dust on the mirror is distracting, the camera can be cleaned at an authorized Minolta service facility.

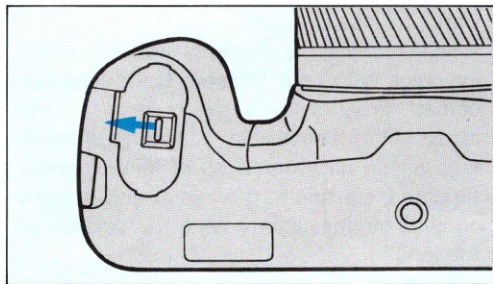

Your Maxxum 5000i uses a 6-volt 2CR5 lithium battery that supplies power for all camera operations.

### Loading the battery

1. With the main switch at **LOCK**, slide the battery-cover release in the direction shown to open the battery cover.

If necessary, wipe battery terminals with a dry cloth to ensure proper contact.

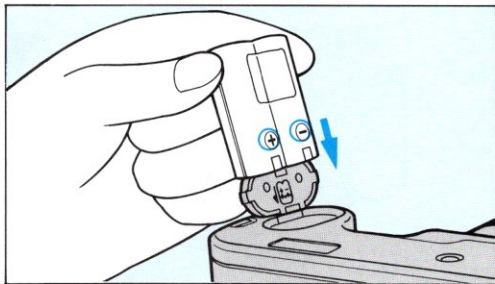





2. Insert the battery as shown, then snap the battery cover closed.

### CAUTION

- Do not mishandle the battery or subject it to high temperatures or fire. The battery may explode or cause burns.
- Read and follow all warnings and instructions supplied by the battery manufacturer.
- Keep batteries away from young children.

## Battery-condition indicators

Each time you slide the main switch from **LOCK** to **ON**, the camera automatically checks the battery and displays a condition indicator in the data panel:

-  1 Full-battery symbol appears for five seconds: Power is sufficient for camera operation.
-  2 Low-battery symbol appears for five seconds: Power is sufficient but getting low—**keep a fresh battery handy**.
-  3 Low-battery symbol blinks: Camera can be operated, **but the battery will need to be changed soon**.
-  4 Blinking low-battery symbol alone, or no display at all appears, the camera beeps, and the shutter cannot be released: Power is too low for normal operation—**replace the battery**.

In cases ③ and ④, the battery-condition indicator appears whenever the shutter-release button is pressed down. If no display appears when the main switch is set to **ON**, double-check that the battery is inserted correctly before inserting a fresh one.

### **Cold-weather operation**

Lithium batteries provide excellent performance in cold weather. However, if you plan to shoot many rolls of film outdoors at temperatures at or below 32°F (0°C), we recommend that you carry the camera inside your coat to keep it warm when you are not taking pictures. You may also wish to carry a spare battery in a warm pocket, so that you can change the battery, if necessary. Do not discard a cold battery. After it warms up, its capacity will be restored.

### **Battery performance**

The 6-volt 2CR5 lithium battery should provide sufficient power for shooting up to 65 rolls of 24-exposure film without flash, or up to 25 rolls of 24-exposure film using the built-in flash in 50% of the exposures. These figures are based on Minolta's standard test method using a fresh battery at 68°F (20°C). Actual battery performance will depend on how you use the camera.

# FILM

## Automatic setting of the film speed

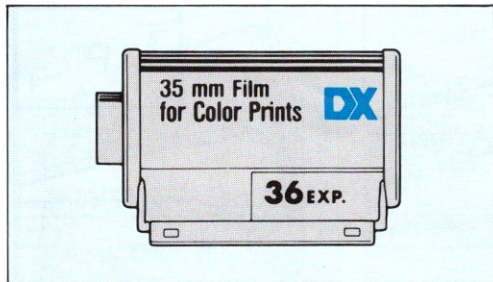

The film speed is set automatically for ISO 25-5000 DX-coded films. If you use film that is not DX-coded, the film speed will be set at ISO 100.

DX-coded films have "DX" printed on their cartridges and film boxes.

## Loading film

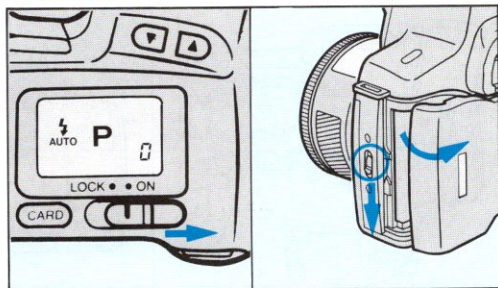

1. Slide the main switch to **ON**.
2. Open the back cover by sliding the release downward. (**When loading film for the first time**, remove and discard the protective plastic cover that is attached to the pressure plate.)

- Before opening the camera back, check that **0** is displayed in the frame counter; if not, film is already loaded and the camera should not be opened. The type of film loaded can be verified by checking the film window. (For instructions to rewind a partially exposed roll of film, refer to pg. 21)
- Always load film in subdued light, or at least shaded from direct sunlight.

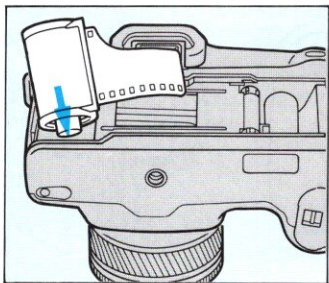

**3.** Place the film cartridge into the film chamber as shown.

**4.** Extend the tip of the film past orange mark. Make sure the holes in the lower edge of the film engage the teeth on the sprocket.

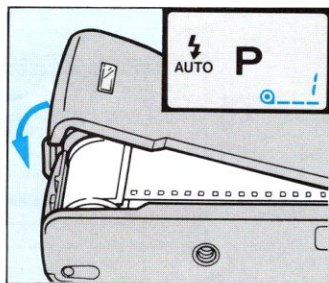
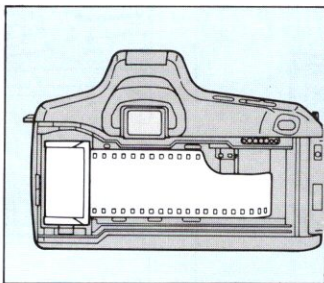

**5.** Close the back cover so that it snaps shut. The camera will automatically wind the film to the first frame, and **1** will appear in the frame counter.

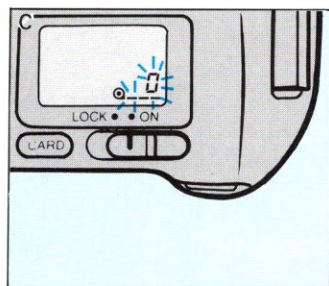
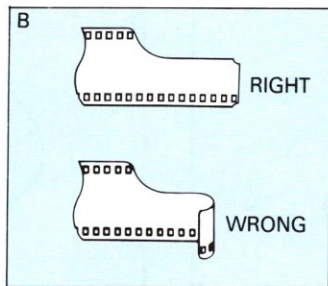
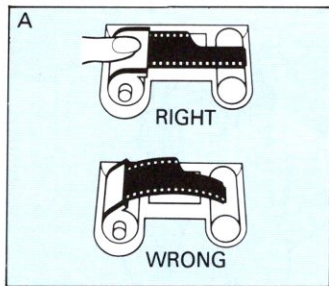

### When loading film:

If the film extends too far or does not lie flat, gently push the excess back into the cartridge (A).

Make sure the tip of the film is shaped correctly. Otherwise, the film may not wind properly (B).

If the film is incorrectly loaded, the frame counter remains at 0 and blinks, and the shutter locks (C). Remove the film and repeat steps 3 to 5.

## HOLDING THE CAMERA



To obtain sharp, blur-free photos, hold the camera as still as possible and steady it against your face or body. To take pictures, press the shutter-release button gently with a slow, steady squeeze- never a quick jab.



Two recommended ways of holding the camera are shown here. If you grasp the camera firmly with your right hand on its handgrip, you can shift the camera back and forth for horizontal (A) and vertical (B) pictures without removing your hands from the controls. When using autofocus, make sure not to touch the lens focusing ring or AF illuminator. Also, be careful not to obstruct the flash when taking pictures.

## SHUTTER-RELEASE BUTTON

In describing camera operation, this manual refers to two shutter-release button operating positions: a pre-release, "partway-down" position, that activates the camera's autofocus and autoexposure systems, and an "all-the-way" down position, that triggers the shutter-release sequence. Both operating positions, as well as the rest position, are illustrated at right.

In automatic operation, focus and exposure are set when the shutter-release button is pressed partway down; autofocus-integrated metering ensures that exposure is correct for the subject that you focus on. Also available is an autoexposure lock function that enables you to control autofocus and autoexposure independently (refer to p. 29).

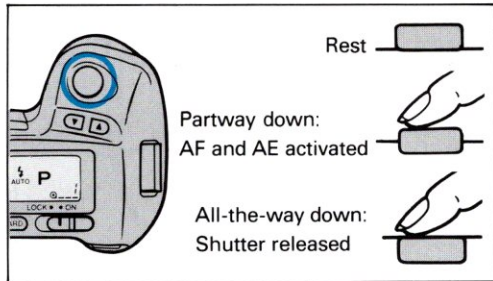

The viewfinder focus and exposure signals function when the shutter-release button is pressed partway down, whether you operate the camera in automatic or manual mode. In manual mode, they can assist you in setting focus and/or exposure.

## TAKING A PICTURE USING AUTOFOCUS AND AUTOEXPOSURE

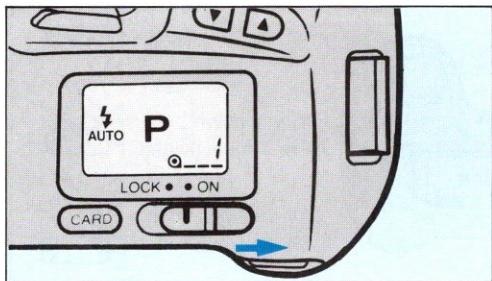

1. Slide the main switch to **ON**.
2. Hold the camera firmly with your right hand on its handgrip and support the lens with your left hand.
3. While looking through the eyepiece, center the focus frame on your subject and gently press the shutter-release button partway down to focus.

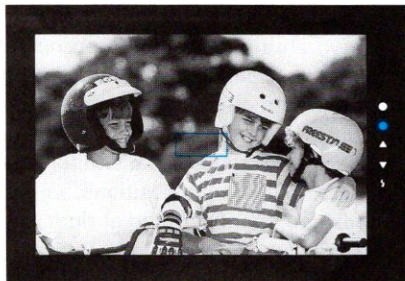

4. When the green focus signal glows, press the shutter-release button all the way down to take the picture.

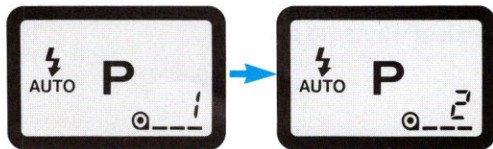

After the picture is taken, the film is automatically advanced and the frame counter increases by one.

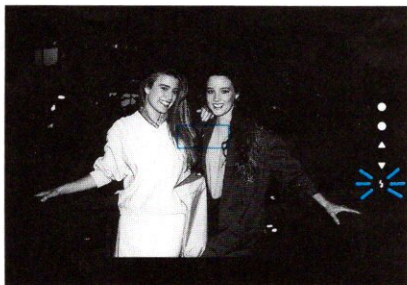

When the metering system determines that flash is required for correct exposure, the flash fires automatically when the picture is taken. If the flash isn't charged, the lower exposure signal glows and the shutter remains locked while charging is in progress; once charging is completed, the flash-ready signal glows and you can take the picture. Refer to the flash section for details about flash operation.

Whenever you turn the camera on, AF mode is automatically set. If the red focus signal blinks when the shutter-release button is pressed down, focus cannot be confirmed by the autofocus system and the shutter remains locked. (Refer to the focusing section.)

Program exposure mode (P mode) and flash operation will be set the first time you turn the camera on. Thereafter, when the camera is turned on, exposure mode and flash settings will remain as they were when the camera was last operated.

## FILM REWIND

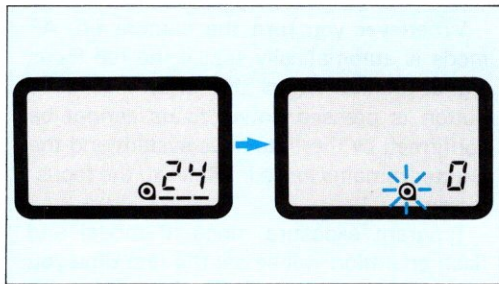

After the last frame on the roll is exposed, the camera automatically starts rewinding the film. With a fresh battery loaded in the camera, it normally takes 12 seconds to rewind a 24-exposure film. While rewind is in progress, the frame counter displays the frame number of the last exposure.

When film rewind is complete, the frame counter displays 0 and the data panel's film-cartridge symbol blinks to indicate that the film cartridge can be removed. Open the camera back and remove the film. The shutter remains locked if a rewound film cartridge is left in the film chamber.

If it's necessary to change batteries before rewind is complete, press the manual rewind button to restart after the new battery is installed.

If you accidentally open the camera back before the film is rewound, close it immediately. Press the manual rewind button to finish rewinding the film. Light falling on the film will ruin many of the pictures, but your quick action may save a few.

## Manual start of film rewind

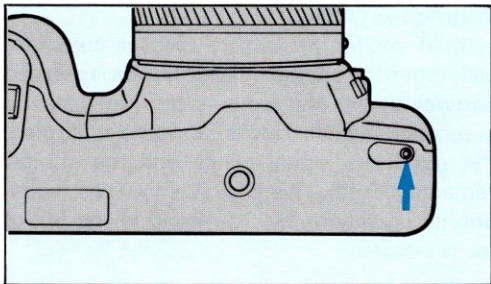

To start rewind manually, use a ball-point pen or similar object to press the manual rewind button. As with automatic rewind, check that the frame counter has returned to **0** before opening the back cover to remove the film.

Before manually starting film rewind, check the battery-condition indicator. If the blinking low-battery symbol is displayed, the battery should be replaced. Although you may be able to take pictures following a low-battery display, film rewind may not operate correctly in this case.

While either autofocus or manual focus can be selected, autofocus is the Maxxum 5000i's standard operating mode and is set whenever the camera is switched on.

To shift between manual and autofocus modes during operation, slide the focus mode switch down. When the camera is set to manual focus, **M. FOCUS** is displayed in the data panel.

### Autofocus (AF)

In AF mode, the camera focuses automatically when the shutter-release button is pressed partway down, and focus is confirmed by the green focus signal; if focus cannot be confirmed, the red focus signal blinks and the shutter remains locked. This design, known as focus-priority operation, lets you avoid taking out-of-focus pictures.

Autofocus operation depends on the detection of subject contrast by the autofocus system. In low light, low contrast situations the AF illuminator is automatically activated when the shutter-release button is pressed down; by projecting a pattern of red light onto the subject, the AF illuminator provides the contrast needed for autofocus operation. The AF illuminator's working range is 1.6 - 16 feet (0.5 - 5m) (based on Minolta's standard test method, using a 50mm lens).

**PREDICTIVE FOCUS CONTROL:** This feature enables you to get sharply focused pictures of approaching subjects. If the AF system detects subject movement when the shutter-release button is pressed down, it continues to adjust focus during the shutter-release sequence (that is, after the shutter-release button is pressed all the way down to take the picture) so that the subject will be sharply focused when the picture is taken.



To take a picture of a moving subject using autofocus, center the focus frame on your subject and press the shutter-release button all the way down to take the picture, without pausing to check for the focus confirmation signal.

If the subject is too close to the camera or moving too fast, the shutter may lock.

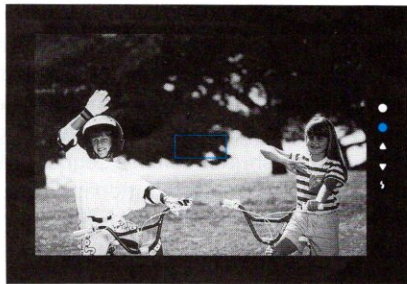
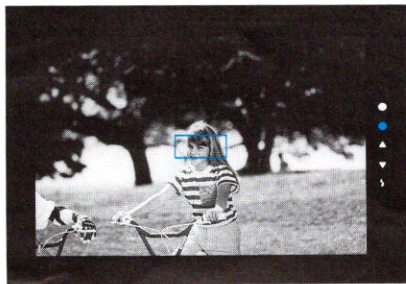

### Focus Hold

This feature should be used for taking pictures in which your subject is positioned outside the viewfinder focus frame.

To take a picture using focus hold, first center the focus frame on your subject, then press the shutter-release button partway down.

When the green focus signal glows, re-compose the picture as needed, keeping the shutter-release button held partway down, then press all-the-way down to take the picture. As long as the green focus signal continues to glow, focus and exposure remain locked on your subject.

When using the Sports Action Card, focus hold does not operate.

## Focusing in special situations

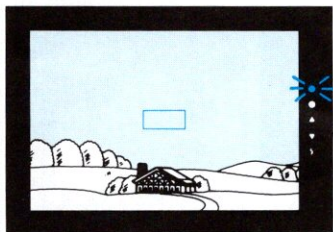

A



B

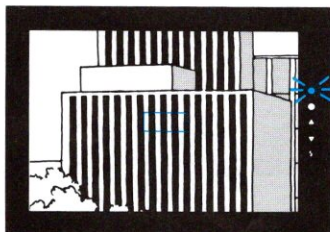

C

The camera's autofocus system will produce sharp pictures in nearly any situation. In those cases where focus cannot be confirmed, the viewfinder's red focus signal blinks, and the shutter locks. Additional steps should be taken to obtain sharp focus:

- If the subject does not have enough contrast, focus manually (A).
- If two subjects are at different distances within the focus frame, focus manually (B).
- If a subject composed of alternating light and dark lines fills the focus frame, focus manually (C).
- For extremely bright subjects, attach a neutral density filter to the lens.
- If the lens focal length is more than 210mm, the AF illuminator will not function, and autofocus may not be possible. In these cases, use focus manually.

## Manual focus

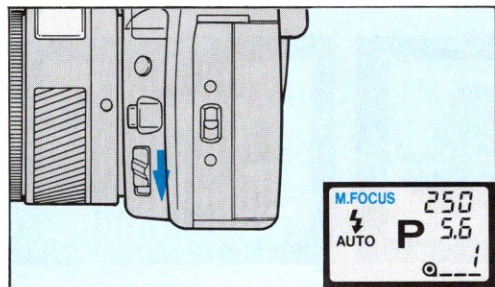

The lens can be focused manually by turning the lens' focusing ring, and checking for sharpness on the focusing screen; if you maintain slight pressure on the shutter-release button, the green focus signal glows and the camera beeps when the subject comes into focus (in low contrast situations where the camera is unable to confirm focus, the red focus signal glows instead).

To use manual focus:

1. Set the camera to manual focus mode by sliding the focus-mode switch down. (**M.FOCUS** is displayed in the data panel when manual focus is set.)

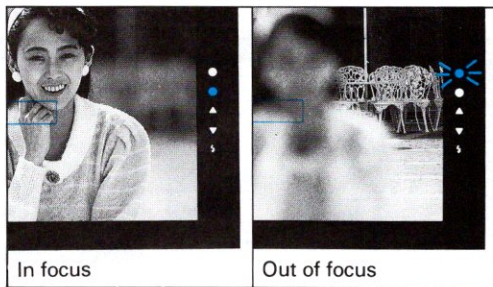

2. Press the shutter-release button partway down to activate the focus signals.
3. Turn the focusing ring until the subject appears sharp on the focusing screen.
4. Press the shutter-release button all-the-way down to take the picture. (When using manual focus, focus-priority operation is not in effect: The shutter can be released at any time, even when the subject is not in focus.)

## EXPOSURE

Your Maxxum 5000i offers both fully automatic Program exposure mode (P mode), in which the camera makes all exposure settings, and Manual exposure mode (M mode), in which aperture and shutter-speed settings are made by the user. In a wide variety of lighting situations, Program mode provides precisely metered, correctly exposed images; in other situations, you may want to exercise more direct control over exposure, and for this purpose Manual mode is suitable.

The optional **A/S Mode Card** allows you to add aperture- and shutter-priority auto-exposure modes to the camera's standard exposure-mode selection.

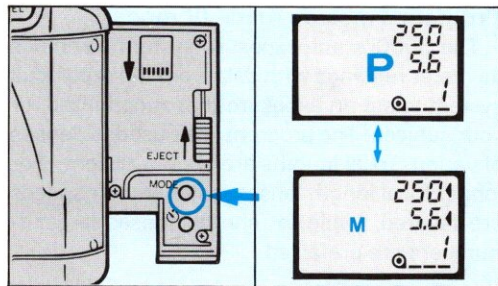

To select the exposure mode, use the **MODE** button housed on the inside of the card door. Pressing the button changes the mode from P mode to M mode, or from M mode to P mode, depending on the current setting; the exposure mode currently set is indicated in the data panel.

If the flash is switched on in P mode and you then set M exposure mode, the flash remains on and will fire each time a picture is taken. In M exposure mode, be sure to switch the flash off if it is not required.

### Program exposure mode (P mode)

The 5000i's autoexposure system combines its meter readings with data from the autofocus system to set an exposure that is optimized for your subject. The program lines used for lenses of various focal lengths are shown at right. For longer focal length lenses faster shutter speeds are favored, while for shorter lenses larger f-numbers are preferred.

Operating the camera in P mode leaves you free to concentrate on composition and other picture elements. When the shutter-release button is pressed partway down, the camera measures the ambient light, automatically determines correct exposure, and displays its program setting in the data panel. If the ambient lighting is not sufficient for correct exposure, the viewfinder's lower exposure signal blinks to indicate that flash should be used. (Refer to the flash section for details about operation).

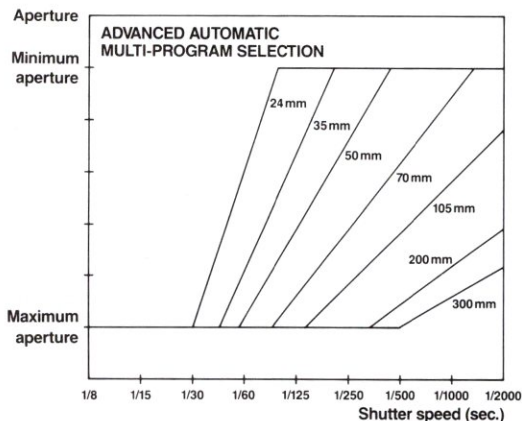

If the required exposure setting is not available, both exposure signals blink; although you can release the shutter, in this case exposure may not be correct.

## Autoexposure lock (AEL)

In P mode, the 5000i's autoexposure lock function lets you control the camera's autoexposure and autofocus system separately.

In regular P mode operation (i.e., without autoexposure lock), autoexposure and autofocus operations are integrated when the shutter-release button is pressed partway down; the camera determines exposure based on the autofocus target, and in most cases this results in correctly exposed pictures. In cases where your main subject consists of very light or dark tones, however, use of autoexposure lock may lead to improved results. By metering a midtone area that receives the same illumination as your main subject, exposure accuracy will be increased.

With the A/S Mode Card, AEL can be used in shutter- and aperture- priority modes as well.

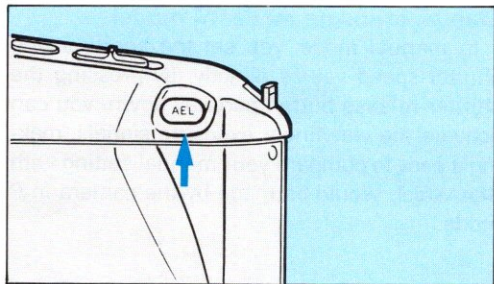

To use autoexposure lock:

1. Center the focus frame on your subject, and press the shutter-release button partway down to focus. When the green focus signal glows, remove your finger from the shutter-release button.
2. Aim the camera so that the midtone subject to be metered fills the viewfinder frame, then press in AEL button.
3. Keeping the AEL button pressed in, compose your subject in the viewfinder frame and release the shutter.

When you use AEL, the metering pattern changes from dual area to center-weighted average.

### Manual exposure mode (M mode)

In manual mode, you set the aperture and shutter-speed values directly; by pressing the shutter-release button partway down, you can activate the viewfinder exposure signals, making it easy to compare your manual setting with that which would be made by the camera in P mode.

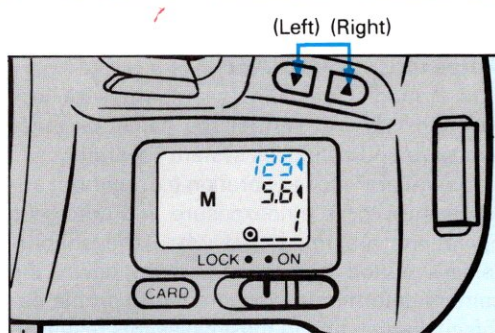

To set the shutter speed: Press the right control key to set a faster shutter speed, and the left control key to set a slower shutter speed.

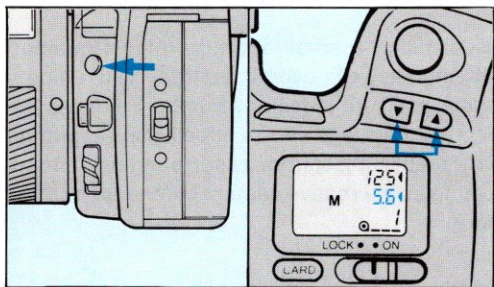

To set the aperture: While holding in the aperture setting button, press the left control key to set a larger aperture number (smaller aperture opening) and the right control key to set a smaller aperture number (larger aperture opening).

When both exposure signals glow, the current exposure setting agrees with the camera's metering program. When the upper or lower signals glow separately, overexposure and underexposure, respectively, are indicated, compared with the exposure that would be set in autoexposure mode. If the overexposure signal glows, increase the shutter speed or the ap-

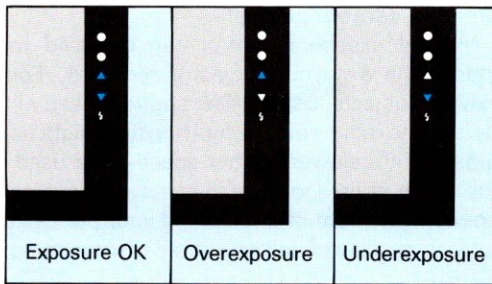

erture number to reduce the exposure; if the underexposure signal glows, use a slower shutter speed, decrease the aperture number, or switch on the flash. For information about using flash in manual mode, refer to the flash section.

If both exposure signals blink, the required setting is not available; although the shutter can be released, in this case exposure may not be correct.

## Creative camera control

Manual exposure control can be used to change the way your subject is recorded. For moving subjects, using a fast shutter speed allows you to reduce picture blurring that might be apparent if a slower shutter speed were used. The depth of field, or overall picture sharpness extending in front of and behind your principal subject, is determined by the aperture setting

used; using a small aperture (high f-number) will increase the overall depth of field; using a larger aperture (smaller f-number) reduces the depth of field, and can be effective in separating your main subject from its surroundings. Some examples of creative camera control are shown here.

**Available shutter speed** (Numbers followed by "are whole seconds; all others are fractional seconds)

2000 - 1000 - 500 - 250 - 125 - 60 - 30 - 15 - 8 - 4 - 2 - 1" - 2" - 4" - (bulb)

**Available apertures, using the AF 50mm f/1.7 lens**

1.7 - 2 - 2.4 - 2.8 - 3.5 - 4 - 4.5 - 5.6 - 6.7 - 8 - 9.5 - 11 - 13 - 16 - 19 - 22

### Creative shutter-speed control



Slow shutter speed

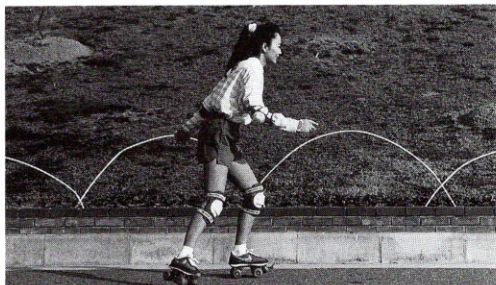

Fast shutter speed

### Creative aperture control

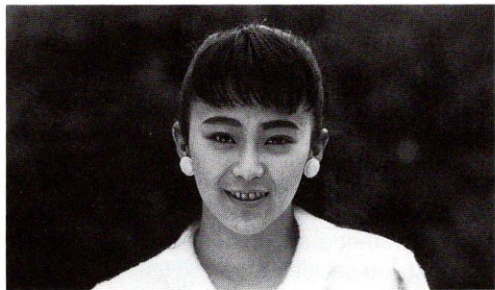

Large aperture

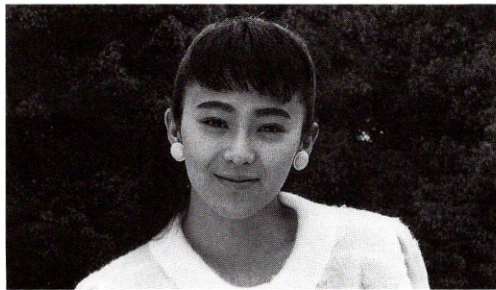

Small aperture

# FLASH

## Using flash

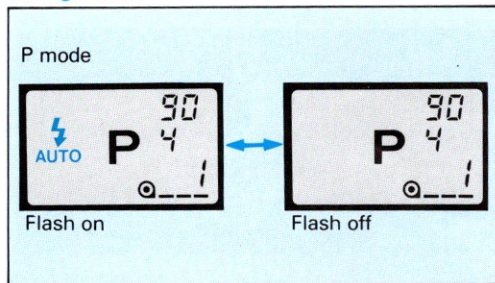

The 5000i's built-in flash is an integral part of the camera's design and makes flash photography completely automatic.

In P mode, whenever the shutter speed is too slow for hand-held pictures, or when the metering system detects that the main subject is backlit, the lower exposure signal blinks to indicate that flash should be used. To switch on the flash, press the flash ON/OFF key. (When you load batteries and turn the camera on for the first time, the flash will be switched to on.)

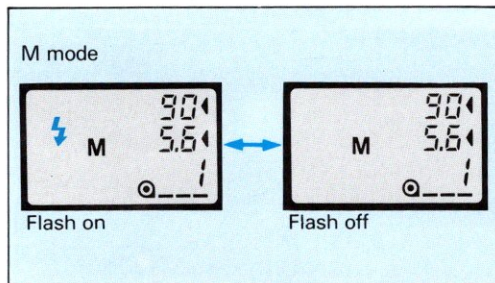

In M mode, you may want to consider using flash whenever the underexposure signal glows. In each exposure mode, the 5000i's TTL OTF (through-the-lens off-the-film) flash metering system controls flash output to ensure correct exposure. Specific information about using flash in P and M modes is given in the following pages.

When the camera indicates that flash should be used due to a slow shutter speed, we recommend attaching the camera to a tripod if you decide not to use flash.

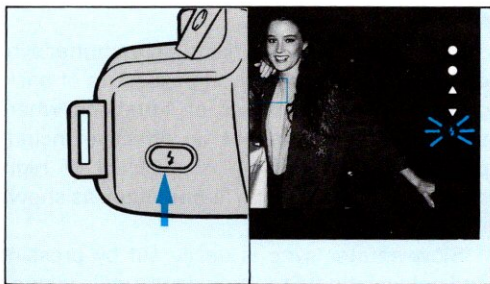

If the lower exposure signal glows when you press the shutter-release button down, the flash is charging and the shutter remains locked. Wait a moment for the flash to finish charging; when the flash-ready signal blinks, press the shutter-release button down to take the picture.

To operate the 5000i's built-in flash:

1. Press the flash ON/OFF key to turn the flash on.
2. Press the shutter-release button partway down to focus.
3. When the flash-ready signal blinks, press the shutter-release button all-the-way down to take the picture. The flash-ready signal blinks rapidly to indicate correct exposure.

With the A/S Mode Card, you can use flash in aperture- and shutter-priority modes as well. In S mode flash operation is the same as in P mode, while in A mode flash operation is the same as M mode.

### Program mode flash operation

When you use flash in P mode, the camera's metering system decides independently whether flash should be used. That is, whenever the camera's meter determines that flash is required — whether due to low-light conditions, or to provide fill flash for backlit subjects — the flash fires automatically when the picture is taken. X-sync shutter speed is automatically adjusted between 1/90 and 1/20 sec.

Using ISO 100 film and a 50mm f/1.7 lens, the flash range is 2.3 - 17 ft. (0.7 - 5.3m) for apertures of f/2.8 and larger. For other apertures and lenses, refer to the flash ranges given in the Manual mode flash operation section.

### Slow shutter sync

In pictures taken with flash, slow-shutter sync can be used to increase the exposure of background areas. Examples of situations where slow-shutter sync might be effective include pictures taken at dawn or dusk, or of night scenes with background illumination, as shown in the example here.

Slow-shutter sync is easily set by pressing and holding the **AEL** button down while taking a flash picture.

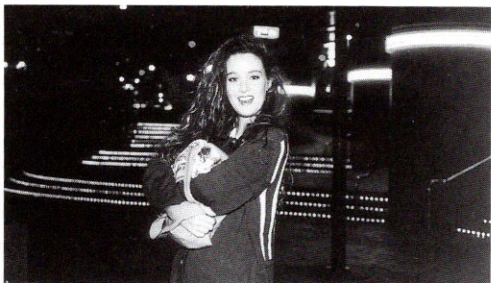

With slow-shutter sync

To use slow-shutter sync:

1. Center the focus frame on your subject, then press the shutter-release button partway down to focus.
2. Press the **AEL** button and then, while keeping it pressed in, press the shutter-release button all-the-way down to take the picture.



With conventional flash

A slower shutter speed is automatically set, and flash output is reduced to prevent overexposure of the main subject. If the shutter speed set in this case is too slow for handheld pictures, use a tripod.

If you use slow shutter-sync in bright conditions, a slower shutter speed may not be set.

With the A/S Mode Card, slow shutter sync can be used in aperture-priority mode as well.

### Manual mode flash operation

Switched on in manual exposure mode, the 5000i's built-in flash fires each time the shutter is released. Any available aperture can be selected, and shutter speeds between 1/90 and 4 sec. can also be used. The flash range will vary according to the both aperture selected and the film speed. The table shown at right lists the flash range for different apertures, using ISO 100 film. For ISO 400 speed film, the far limit of each range listed is doubled.

Aperture	Flash Range
1.4	2.3-33 ft. (0.7-10m)
2	2.3-23 ft. (0.7-7m)
2.8	2.3-16 ft. (0.7-5m)
4	2.3-11 ft. (0.7-3.5m)
5.6	2.3-8.2 ft. (0.7-2.5m)
8	2.3-5.6 ft. (0.7-1.7m)

If the aperture in use is a half-stop value falling between those listed, the far limit of the flash range will be approximately halfway between the far limits of the neighboring values. (For example, if the aperture setting is f/4.5, the flash range is approximately 2.3-9.8 ft.)

## Important information on using flash

For pictures taken using the built-in flash, the camera-subject distance should be at least 2.3 ft. (0.7m). Use of a lens hood is not recommended, since image vignetting may occur; for lenses with detachable hoods, the hood should be removed from the lens (not mounted in the inverted position).

Vignetting may also occur when the 5000i's built-in flash is used together with certain lenses; before taking flash pictures with any of the lenses listed below, please check with the nearest Minolta Service Facility for specific limitations.

AF 35mm	f/1.4
AF 28-85mm	f/3.5-4.5
AF 28-135mm	f/4-4.5
AF 35-105mm	f/3.5-4.5 (with Macro release)
AF 70-210mm	f/4
AF 75-300mm	f/4.5-5.6
AF 80-200mm	f/2.8

In pictures of people taken with flash, your subjects' eyes may appear red. "Red-eye", as the effect is called, is caused by light from the flash reflected back into the lens from the subject's retinas, and will be more noticeable in some subjects than in others. To minimize red-eye, we recommend increasing the overall light level as much as possible, and getting as close as possible to the near end of the flash range without the flash discharge becoming a disturbance. If redeye persists, try switching off the built-in flash and attaching a separate unit for improved results.

Always use care when taking flash pictures of people or animals, since the flash discharge may be disturbing.

## ADDITIONAL INFORMATION

### Main switch

When the main switch is at **ON** all functions on the camera will operate and you can take pictures. At **LOCK** position, all camera functions are switched off. When not using the camera, set the main switch to **LOCK** to prevent accidental exposures and ensure optimum battery life.

When you switch the camera on, with a Maxxum AF lens attached, the camera's autofocus system adjusts the lens extension in preparation for autofocus operation. Similarly, when the camera is switched to **LOCK**, the autofocus system automatically retracts the lens to its shortest extension for ease of carrying or storage.

The frame number and film-transport signal remain visible on the top-mounted data panel for about one hour after the camera is switched off. The display reappears when the camera is turned on.

### Audible signals

In the cases listed below, the camera emits a short beep to assist you in operating the camera.

- When the film is loaded incorrectly
- When the subject comes into focus
- When using the self-timer
- When HELP is displayed in the data panel.
- When the battery is exhausted
- When the shutter speed is too slow for blur-free, hand-held pictures. In this case, the lower exposure signal in the viewfinder blinks as an additional warning.
- When the shutter-release button is pressed down during flash charge.

In the last two cases, cancellation of the audible signal is possible by moving the main switch from **LOCK** to **ON** while holding down the control keys.

## Self-timer

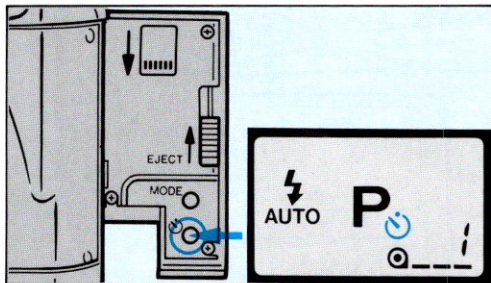

The 5000i's self-timer allows you to set a ten second shutter-release delay.

Before starting the self-timer, confirm that focus is correctly set by checking for the green focus signal; autofocus does not function once the self-timer is started.

To use the self-timer:

1. Open the card door and press the self-timer (☺) button. The self-timer symbol (☺) will appear in the data panel.
2. Focus the lens and attach the eyepiece cap.
3. Press the shutter-release button all the way down to start the self-timer.

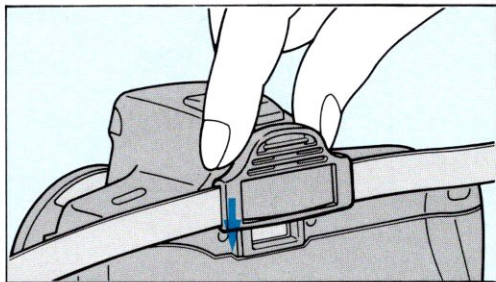

The self-timer light blinks and the camera beeps twice a second, until the picture is taken.

To take another picture using the self-timer, repeat steps 1-3.

To cancel the self timer before the shutter-release button has been pressed, press the self-timer button again. To cancel the self-timer after the shutter-release button has been pressed, slide the main switch to **LOCK**.

## Long exposures

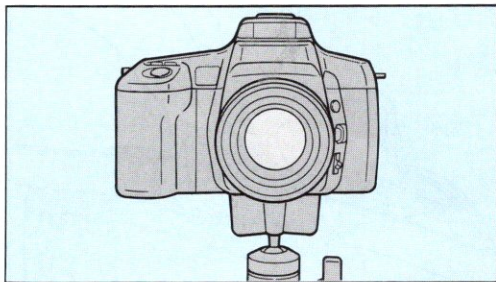

The bulb shutter-speed position can be used for making exposures longer than 4 seconds in duration. Long exposures are appropriate for photographing a variety of subjects, including fireworks, lightning storms, city skylines after sunset, etc. To make long exposures:

1. Mount the camera on a tripod. Be careful not to overtighten the tripod's mounting screw, and not to use a screw longer than 1/4 in. (5.4mm).

For extended exposures using the bulb setting, installation of a fresh battery is recommended

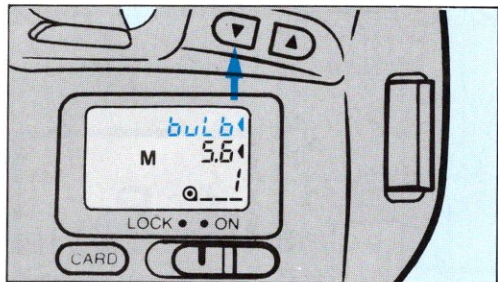

2. Set the camera to Manual exposure mode, then press and hold the left control key until **bulb** appears in the data panel.

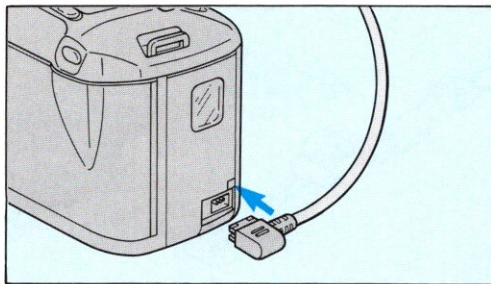
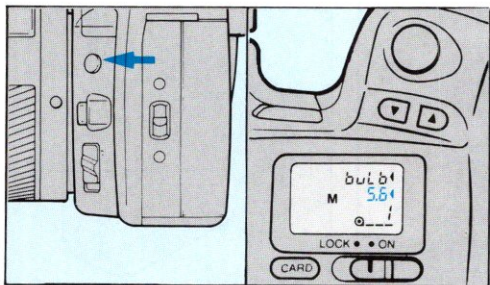

3. Set the aperture.
4. Focus the lens. (If the light is too dim for autofocus, set the focus mode to manual and turn the lens focusing ring until the subject is sharp.)
5. Release the shutter. (At the **bulb** setting, the shutter remains open as long as the shutter-release button is held down.)

For making long exposures, use of a remote cord, either RC-1000S or RC-1000L, is strongly recommended to minimize camera shake. Both cords have locking shutter-release buttons, convenient for keeping the shutter open for extended periods.

To attach a remote cord, remove the remote control terminal cover and insert the remote cord plug.

## Attaching the Neckstrap and Eyepiece Cap

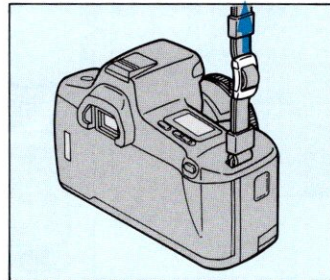
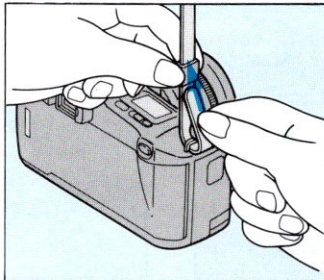
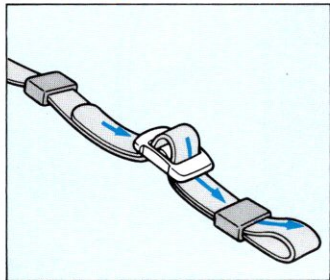

A neckstrap is supplied with your Maxxum 5000i. Attach it to the camera as shown above.

An eyepiece cap is also supplied and can be slipped onto the neckstrap to keep it handy for use.

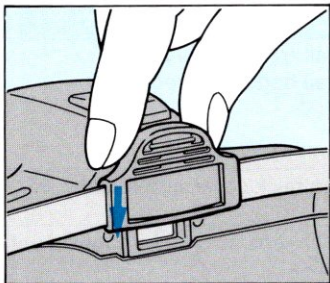

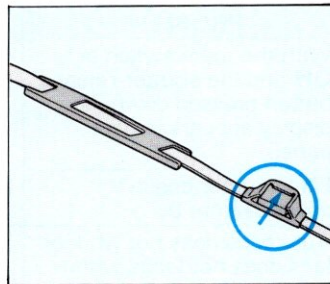
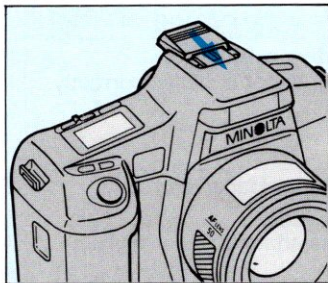

The eyepiece cap slides over the eyepiece to prevent stray light from entering the camera and affecting exposure. It should be used whenever the eyepiece is not shielded by your head, as when using the self-timer or when operating the camera by remote control. To attach the eyepiece cap, first remove the eyepiece cup, then slip the cap over the frame.



An accessory shoe cap is supplied that slips into the accessory shoe to protect the contacts from dust and grime. When using a flash unit, slip the accessory shoe cap into the eyepiece cap.

## TROUBLESHOOTING

PROBLEM	CAUSE	SOLUTION
With the main switch at <b>ON</b> and the shutter-release button pressed down, no display appears in data panel.	Battery exhausted. Battery not installed correctly.	Install fresh battery. Install battery correctly.
Film counter doesn't advance from <b>0</b> .	Film not loaded correctly.	Open back cover and reload film.
Autofocus does not work or lens does not focus when shutter-release button is pressed.	Lens attached incorrectly.  Manual focus mode set.  Subject difficult to focus. Zooming grip of lens in use positioned in macro range.	Attach lens so it locks in place with a click. Use focus mode switch to set AF mode. Use manual focus. Slide and hold macro release, then turn zooming grip back into zoom range.

PROBLEM	CAUSE	SOLUTION
HELP is displayed in data panel.	Motor problem.	Remove and reinstall battery.
Flash ready signal (  ) in the viewfinder does not appear.	Flash switched off. Flash is not attached to camera correctly.	Switch flash on. Attach the flash to the camera's accessory shoe so that it locks in place with a click.
Shutter cannot be released.	Main switch at LOCK. Film cartridge remains in camera after film is completely rewound. Flash not charged.  Film loaded incorrectly. In AF mode, focus cannot be confirmed.	Slide main switch to ON. Remove film cartridge from camera.  Wait until the flash-ready signal (  ) blinks, then press down fully to take the picture. Reload film. Switch to manual focus mode and focus manually.



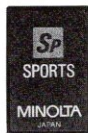

**Sports Action Card** — Controls the camera's basic settings for taking pictures of fast-moving subjects. The autoexposure program is automatically shifted according to subject distance and lens focal length in use.

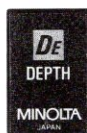

**Automatic Depth Control Card** — This card automatically controls the camera's aperture setting to maximize depth of field so that both foreground and background subjects will be in sharp focus.

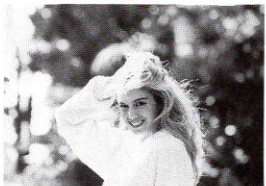

**Portrait Card** — Uses a special exposure program to provide depth of field suitable for portraits. This program automatically adjusts aperture and shutter speed so that your subject is separated from the background.

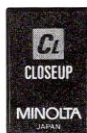

**Close-up Card** — Sets a special exposure program that provides depth of field suitable for close-up and macro shots. It sets the aperture based on subject magnification and selects the shutter speed to provide correct exposure at that aperture.

## Minolta AF Lenses

The entire system of Maxxum AF lenses are usable with your Maxxum 5000i camera. Besides the ergonomically designed, compact AF 35-80mm, AF 35-105mm, AF 70-210mm, AF 100-300mm and AF 80-200 zoom lenses and the new AF Reflex 500mm lens, a growing range of wideangle, zoom, and macro lenses is available. Visit your Minolta dealer for more information about Maxxum AF lenses and accessories.

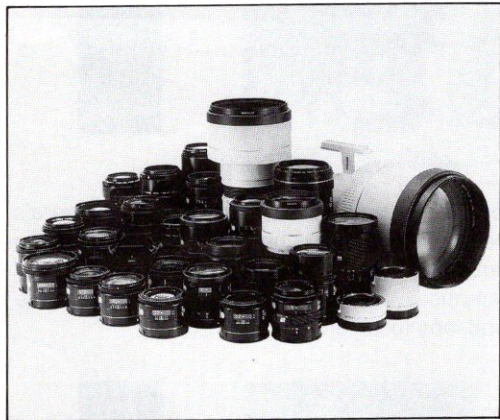

## Accessory Flash Units

A number of accessory flash units are available for use with the 5000i. The 5000i's flash ON/OFF key controls only the camera's built-in flash; accessory units must be turned on and off separately. When using an accessory flash, turn off the camera's built-in flash.



### Maxxum Flash 3200i and 2000i

These two units are designed specifically for use with Maxxum i-series autofocus cameras, including the 5000i. They can be quickly and securely attached to the camera's accessory shoe. Once switched on, they operate in the same way as the camera's built-in flash, according to the exposure mode selected.

The Maxxum Flash 3200i features a guide number of 105 (in feet), and automatically zooms to provide appropriate flash coverage for 28mm to 85mm lenses. The Maxxum Flash 2000i, with a guide number of 66 (in feet), is a good choice for situations where less flash power is needed.

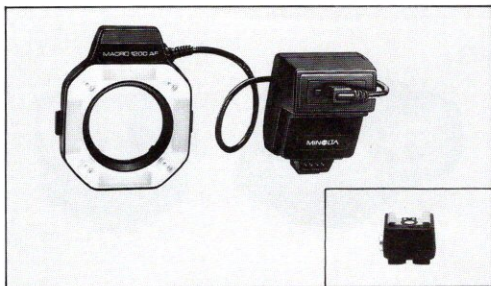

### Macro Flash 1200AF Set-N

Macro Flash 1200AF Set-N is a specially designed unit that attaches to the 5000i via the Flash Shoe Adapter FS-1100. This unit has four flash tubes that can be controlled separately for versatile lighting control. Four focusing lamps provide illumination for focusing and TTL flash metering ensures accurate exposure at closeup and macro ranges. Used with the 5000i, this unit fires whenever the shutter is released, regardless of the exposure mode selected.

### Other Flashes

The Flash Shoe Adapter FS-1100 must be used to attach the Maxxum Flash 4000AF, 2800AF, or 1800AF to the Maxxum 5000i. Used with the 5000i, these units fire whenever a picture is taken, regardless of the exposure mode selected.

The AF illuminators in the 4000AF, 2800AF and 1800AF do not operate when used with the Maxxum 5000i. However, the camera's built-in AF illuminator provides for low-light, low-contrast autofocusing.

When using Maxxum Flash 4000AF, the far limit of the flash range displayed on its data panel may be larger than the actual maximum distance. If your subject is close to the maximum distance, it may be underexposed. Correct exposure is confirmed by the glowing **OK EXP** signal; confirmation of correct exposure is also given by rapid blinking of the viewfinder's flash ready signal.

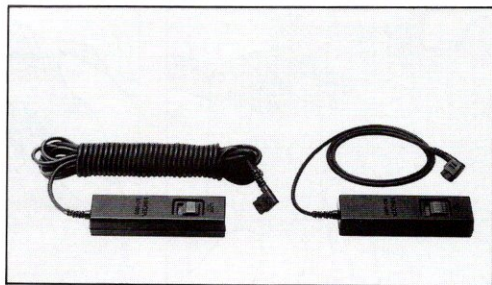

### Data back

Data Back DB-5 permits imprinting of time and date information directly on the film, including year/month/day in three possible sequences, and day with 24 hour time. A single 3-volt lithium battery is installed at the factory and supplies power for data imprinting and for the automatic calendar and clock.

### Remote Cord RC-1000L and RC-1000S

A remote cord should be used for taking long exposures (**bulb** setting), or anytime camera shake is likely to affect pictures. Autofocusing and metering are both activated by pressing the cord's release button. RC-1000L is 16.5 ft. (5m) long, and RC-1000S is 20 in. (0.5m) in length.

## Cases

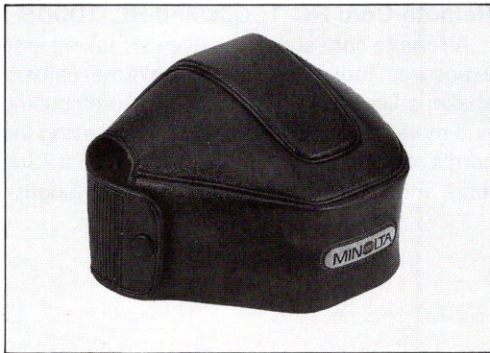
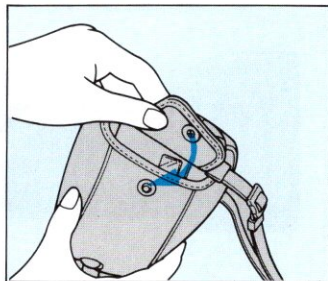
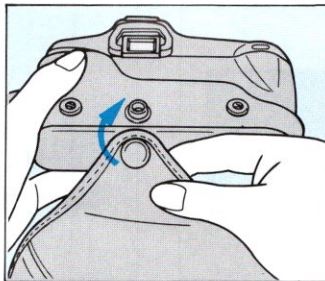
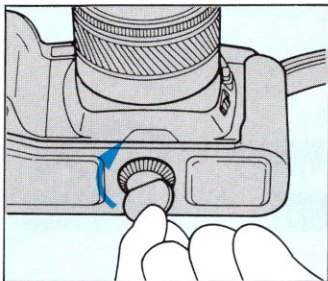

CH-500

Various camera cases are available as optional accessories for the Maxxum 5000i. To put the camera in its case:

1. Attach the lens cap. (With the AF 35-80mm or AF 80-200mm, close the lens cover.)
2. If a zoom lens is attached to the camera, turn the zoom ring until the lens barrel is at its shortest position.
3. Follow the diagrams to put the camera in its case.

### **Eyepiece Corrector 1000**

Nine eyepiece-correction lenses are available for dioptic adjustment of the eyepiece. These lenses can be purchased separately and range from  $-4$  to  $+3$  diopters. The lenses snap into the camera's eyepiece frame.

### **Filters**

Autofocusing can be done with these Minolta filters: L37 (UV), Y52 (yellow), G0 (green), O56 (orange), R60 (red), 1B (skylight), A 12 (85), B 12 (80B), ND4X (two-stop neutral density), Minolta Portrayer filters, and Minolta Polarizing (Circular) filters.

## TECHNICAL DETAILS

**Type:** 35mm SLR with built-in flash and intelligent control of autofocus (AF), autoexposure (AE) and film transport systems

**Lens mount:** Minolta A-type bayonet; accepts all Maxxum AF lenses

**Autofocus system:** Minolta's through-the-lens (TTL) phase-detection type with wide charge-coupled device (CCD) sensor; sensitivity range: EV 0 to 18 at ISO 100 in ambient light; Predictive focus control; built-in AF illuminator automatically activated in low light, low contrast; range: 1.6 to 16 feet (0.5 to 5 meters), based on Minolta's standard test method

**Manual focusing:** Visually on Acute-Matte viewfinder screen, confirmed by viewfinder focus signal

**Metering:** TTL dual-area contrast detection metering coupled to autofocus system; exposure locked when focus is locked in autofocus mode; two-segment silicon photocell (SPC) for ambient light; second SPC at bottom of mirror box for TTL flash metering with built-in flash and other dedicated flash units; AEL (automatic-exposure lock) button can be used to override shutter-release button AE-lock function with previously memorized exposure reading

**Auto-Exposure (AE) range:** EV 1 to 20 with ISO 100 film and 50/1.4 lens

### Exposure modes:

**Program AE:** Automatic multi-program selection sets autoexposure program, based on lens focal length in use; shutter speed and aperture determined by autoexposure (AE) program; exposure is locked together with focus when green viewfinder signal glows

**Manual:** Any shutter-speed and aperture combination usable; correct exposure and over-/under- exposure indicated in viewfinder; **bulb** setting for long exposures

(Shutter-priority AE (S) and aperture-priority AE (A) available with optional A/S Mode Card)

**Shutter:** Electronically controlled vertical-traverse focal-plane type; range 1/2000 to 4 seconds

**Shutter-release button:** Pressing button partway down activates autofocus and metering systems (in AF and AE modes, exposure and focus are set and locked, as well); pressing button all-the-way down releases shutter; in AF mode, shutter can be released only when subject is in focus (focus-priority operation)

**Controls:** Buttons to set exposure mode, AE lock, flash on/off, and self-timer operation; control keys to manually set aperture and shutter-speed

**Flash sync:** X-sync speed automatically set from 1/90 sec. to 1/20 sec according to focal length of lens in use and ambient light level;

**Built-in flash:** On/off control; in P and S modes, flash fires automatically when required; in M and A modes flash fires each time shutter is released; guide number: 52 (70mm coverage) to 46 (35mm coverage) in feet (16 to 14 in meters), according to lens focal length setting; recycle time: approx. 5 sec.

**Film-speed settings:** Automatic setting for DX-coded ISO 25 to 5000 film; ISO 25 to 5000 in ambient light, ISO 25 to 1000 for TTL flash metering; film speed set to ISO 100 for film without DX coding.

**Film transport:** Auto threading, auto advance to first frame, single frame advance; automatic or manual rewind start; advancing frame counter in data panel

**Viewfinder:** Eye level fixed roof mirror shows 90% of field of view; magnification 0.75X with 50mm lens at infinity

**Data displays:**

Data Panel: Liquid-crystal display (LCD) shows exposure mode, shutter-speed, aperture, flash on, manual focus mode, **bulb** operation, card name, card in use, frame number, self-timer operation, battery condition

Viewfinder: Light-emitting diodes (LED) signal focus status, use flash, flash ready, over-/under- and correct exposure, required exposure not available, and sufficient flash exposure

**Power:** 6-volt 2CR5 lithium battery powers camera; automatic battery check when camera is turned on; battery condition indicated by four-stage indicator in data panel; shutter locks when battery is exhausted; main switch has LOCK and ON positions

**Audible signals:** With main switch at ON position, audible signal for subject in focus, self-timer operation, slow-shutter speed, flash charging, film loaded incorrectly, battery exhausted, and when HELP is displayed in the data panel

**Self-timer:** Electronic with 10-second delay; cancelable; operation indicated by audible signal and blinking LED

**Size and weight:** 5-7/8 x 3-13/16 x 2-9/16 in. (148.5 X 97.5 X 65mm), 17-5/8 oz. (500g) without lens and battery

**Optional Accessories:** Accepts all Maxxum AF lenses, Maxxum Flashes 2000i and 3200i, Creative Expansion Cards (A/S Mode Card and Special Application Cards), Data Back DB-5, Remote Cord RC-1000L and Remote Cord RC-1000S, Eyepiece Correctors, and flash accessories including off-camera cables and connectors

Specifications subject to change without notice

## CARE AND STORAGE

- Always keep your camera in its case with the lens capped when not in use, or with a body cap on when a lens is not attached.
- No part of the camera should be forced at any time.
- Never subject your camera to shock, high heat, humidity, water, or harmful chemicals. Be particularly careful not to leave it in the glove compartment or other places in motor vehicles where it may be subjected to high temperatures.
- Never lubricate any part of the camera body or lens.
- Never touch the shutter curtains, mirror, or the front inside parts of the body or clean them with compressed air. Doing so may impair their alignment and movement.
- External camera surfaces and lens barrel — but not glass surfaces — can be cleaned by wiping with a dry or silicone-treated cloth.
- Never touch the lens or eyepiece surfaces with your fingers. Whisk away loose matter with a blower brush. To remove stubborn spots, use a sheet of photographic lens tissue. If necessary, tissue may be moistened with one drop of lens-cleaning fluid. Never place fluid directly on glass surfaces.
- We recommend that you have your camera cleaned once a year at an authorized Minolta service facility.

● If you plan to store your camera for an extended period of time, rewind and remove the film, then remove the battery. Place the camera in a cool, dry place away from dust or chemicals, preferably in an airtight container with a drying agent such as silica gel.

● After prolonged storage, and especially before taking pictures at an important event, carefully check the operation of the camera and lens.

● The operating range for the LCD (liquid crystal display) data panel is from  $-4^{\circ}$  to  $122^{\circ}\text{F}$  ( $-20^{\circ}$  to  $50^{\circ}\text{C}$ ). At temperatures outside this range, response time and contrast will change, making the display difficult to read. At very high temperatures, a display may temporarily darken. If this occurs, the display should return when the camera is restored to operating range conditions.

● The Maxxum 5000i contains no user-serviceable parts. Do not attempt to disassemble or repair the camera yourself.

● The Maxxum 5000i's circuitry may switch off, even when a battery with sufficient power is installed. To resume operation, remove the battery and install it again.

Save the camera box and packing material. When shipping your camera, carefully repack it in the box, insure adequately, and use a reliable delivery service.

Before shipping your camera for repairs, contact your nearest authorized Minolta service facility.

**Minolta Camera Co., Ltd.**

**3-13, 2-Chome, Azuchi-Machi, Chuo-Ku, Osaka 541, Japan**

**Minolta Corporation**

**Head Office**

101 Williams Drive, Ramsey, New Jersey 07446, U.S.A.

**Los Angeles Branch**

11150 Hope Street Cypress, CA 90630, U.S.A.

**Chicago Branch**

3000 Tollview Drive, Rolling Meadows, IL 60008, U.S.A.

**Atlanta Branch**

5904 Peachtree Corners East, Norcross, GA 30071, U.S.A.

**Minolta Canada Inc.**

**Head Office**

369 Britannia Road East, Mississauga, Ontario L4Z 2H5, Canada

**Montreal Branch**

376 rue McArthur, St. Laurent, Quebec H4T 1X8, Canada

**Vancouver Branch**

105-3830 Jacombs Road, Richmond, B.C. V6V 1Y6, Canada

**Minolta GmbH**

Kurt-Fischer-Strasse 50, D-2070 Ahrensburg, West Germany

**Minolta France S.A.**

357 bis, rue d'Estienne d'Orves, 92700 Colombes, France

**Minolta (UK) Limited**

1-3 Tanners Drive, Blakelands North, Milton Keynes, MK14 5BU, England

**Minolta Austria Gesellschaft m.b.H.**

Amalienstrasse 59-61, 1131 Wien, Austria

**Minolta Camera Benelux B.V.**

Zonnebaan 39, 3606 CH Maarssenbroek, P.B. 264, 3600 AG Maarssen,  
The Netherlands

**Belgium Branch**

Stenen Brug 115-117, 2200 Antwerpen, Belgium

**Minolta (Schweiz) AG**

Riedhof V, Riedstrasse 6 8953 Dietikon-Zürich, Switzerland

**Minolta Svenska AB**

Brännkyrkagatan 64, Box 17074, S-10462 Stockholm 17, Sweden

**Minolta Hong Kong Limited**

Room 208, 2/F, Eastern Center, 1065 King's Road, Quarry Bay, Hong Kong

**Minolta Singapore (Pte) Ltd.**

10, Teban Gardens Crescent, Singapore 2260



MINOLTA

9222-2077-31

© 1989 Minolta Camera Co., Ltd. under the Berne  
Convention and Universal Copyright Convention

N006-A6 Printed in Japan