

JANUARY 1952

PARTS LIST No. 5206

**KODAK RETINA IIa CAMERA**  
with  
**Kodak Synchrono-Compur Shutter**  
or  
**Kodak Compur-Rapid Shutter (Flash Model)**

This list covers the Kodak Retina IIa Camera *Flash Model* only and has no reference to the non-flash model. Due to manufacturing changes, some of the camera parts on the Kodak Retina IIa Camera, *Flash Model* are not interchangeable. These noninterchangeable parts are identified by the serial number of the camera.

Shutter parts are on pages 16 through 24. Parts which are common to both shutters are identified by part number and name. Noninterchangeable shutter parts are identified by the shutter name.

Some of the parts illustrated in this list may be the same as, or interchangeable with, the parts for other models. However, unless you are certain that you are requesting the correct part, we recommend that a sample part accompany your order. Use N numbers when ordering parts from Repair Parts Service, Eastman Kodak Company, Rochester 4, New York. The Stuttgart, Germany factory number is indicated by (G).

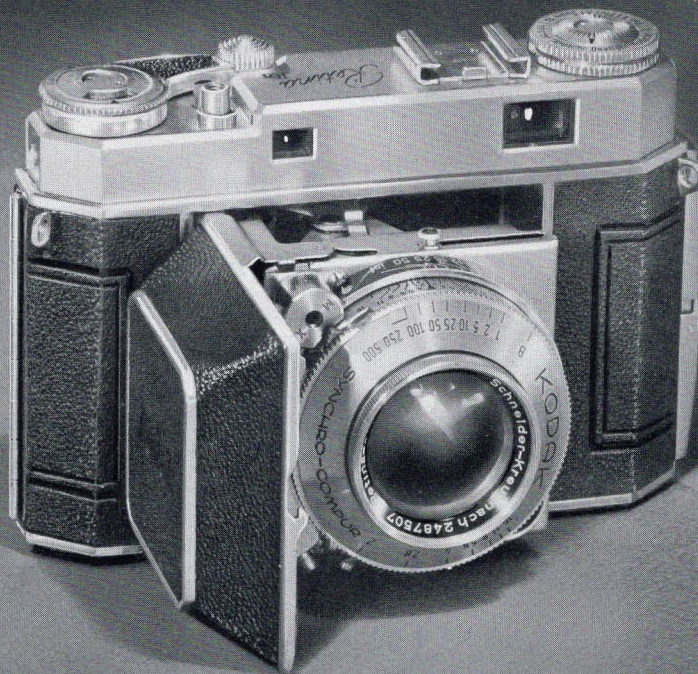

# KODAK RETINA IIa CAMERA

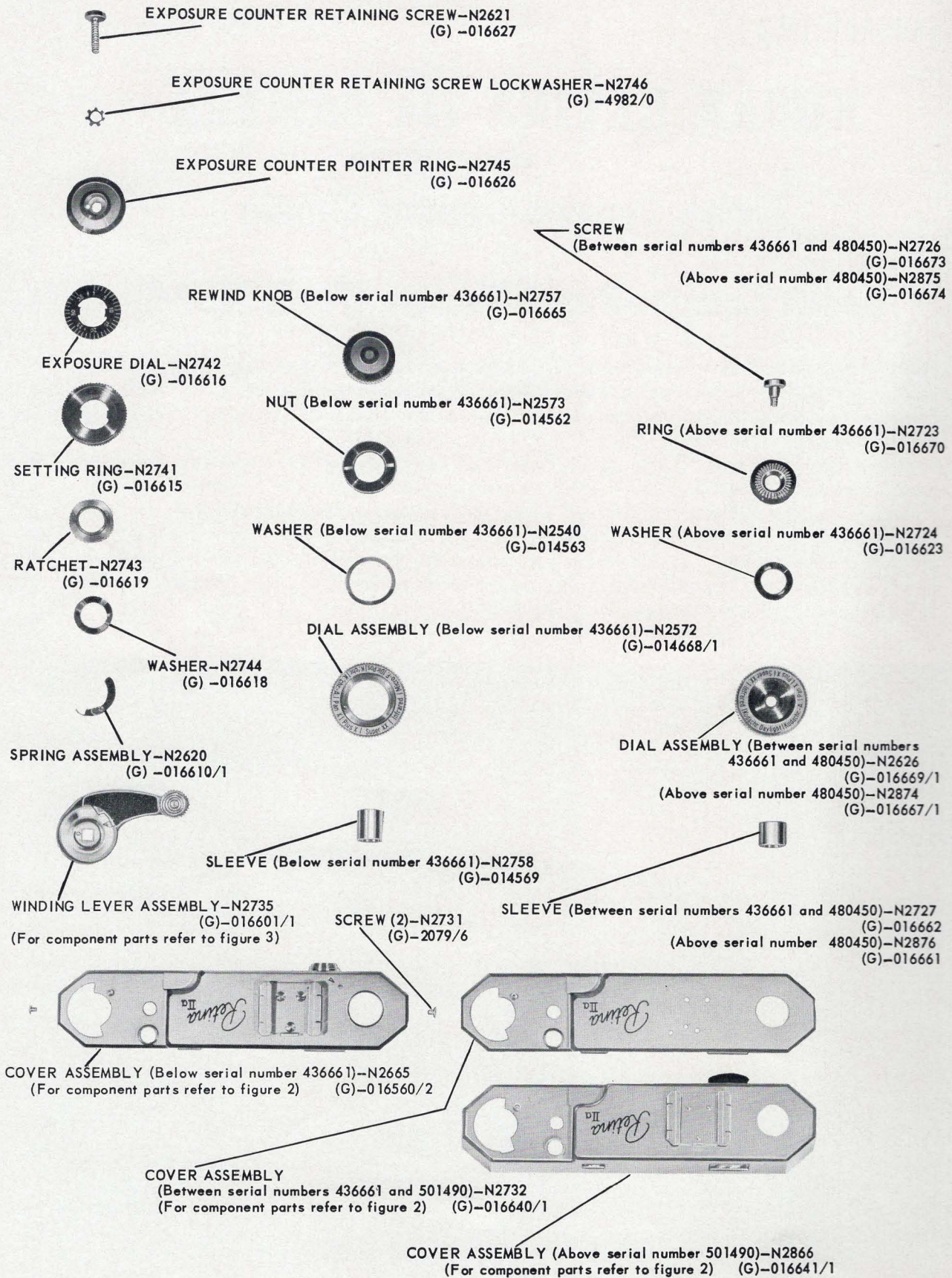

**FIGURE 1**

KODAK RETINA II<sub>a</sub> CAMERA

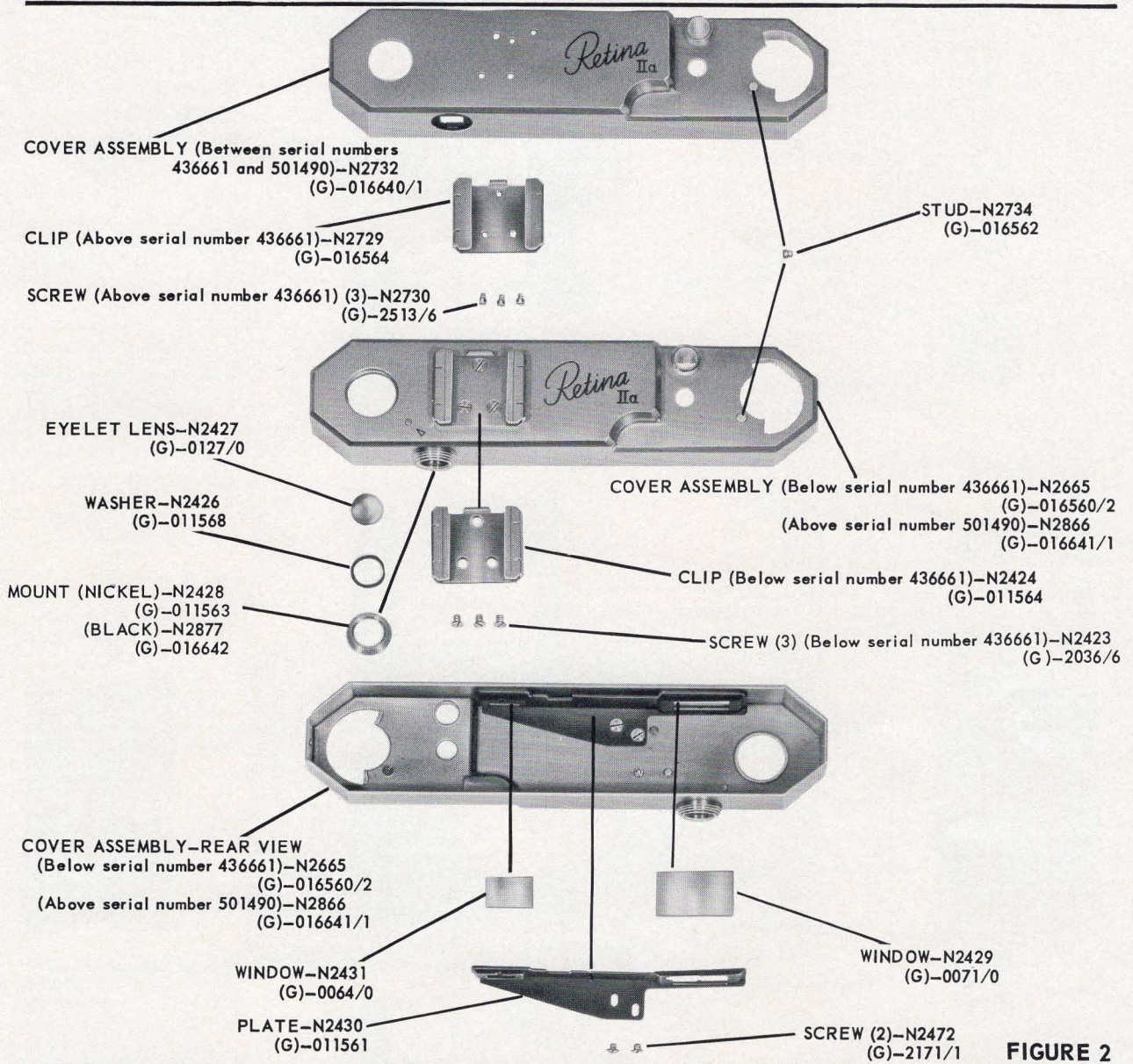
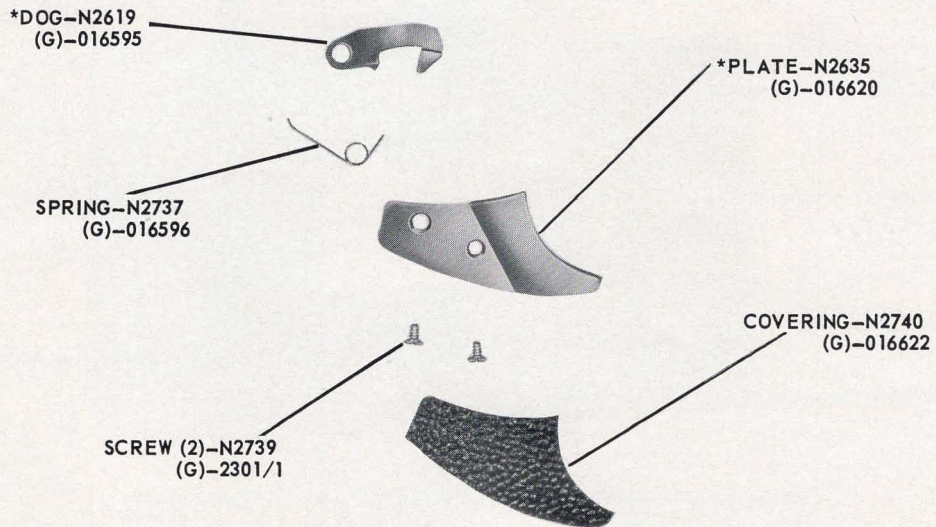

FIGURE 2



\*THESE PARTS SHOULD BE REPLACED IN PAIRS

FIGURE 3

Always give PART NUMBER and NAME when ordering parts

# KODAK RETINA IIa CAMERA

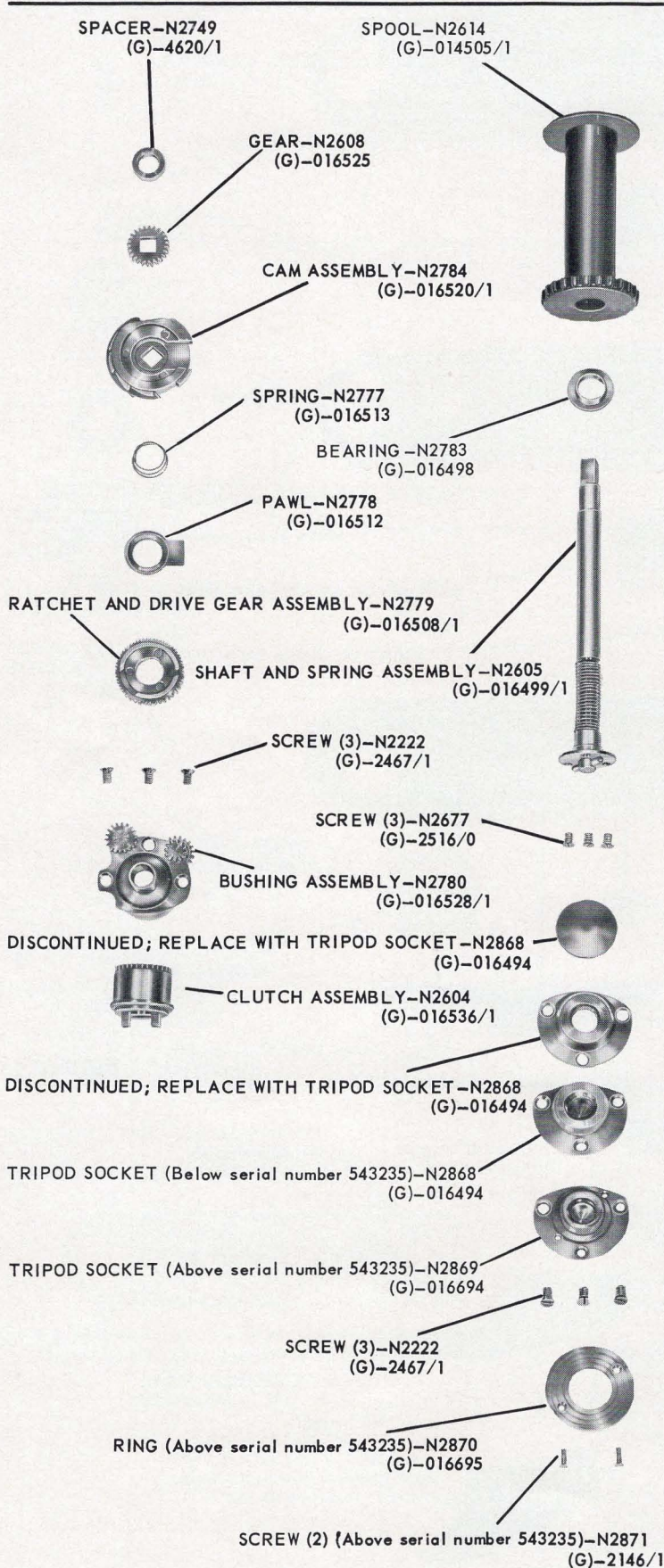

**FIGURE 4**

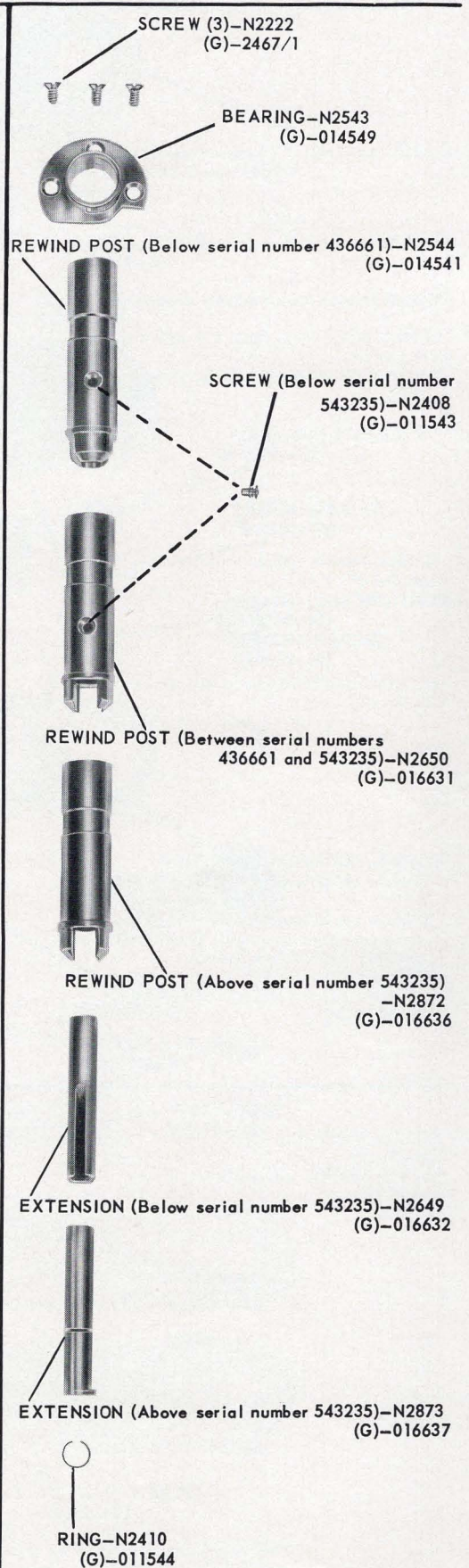

**FIGURE 5**

KODAK RETINA IIa CAMERA

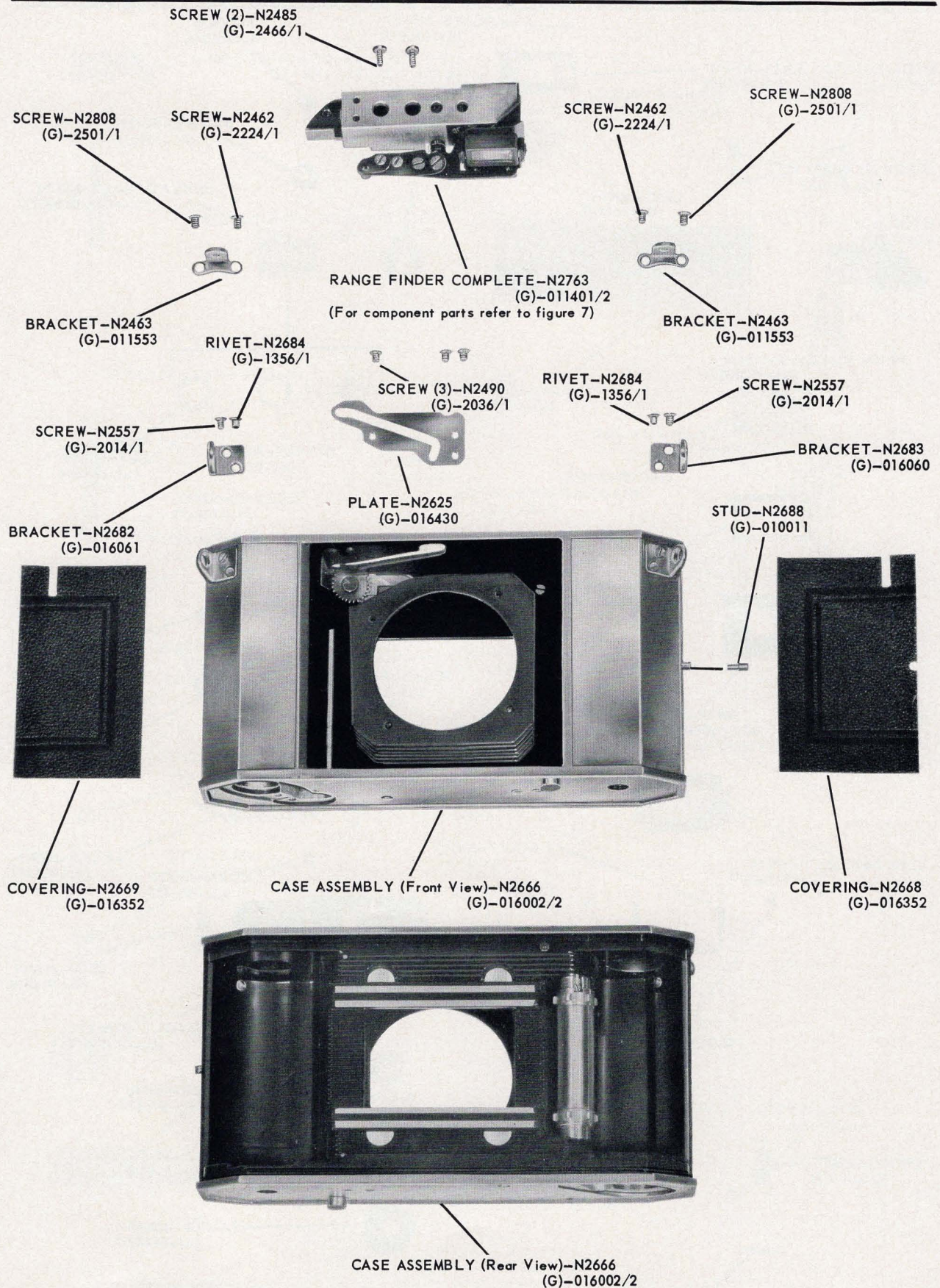
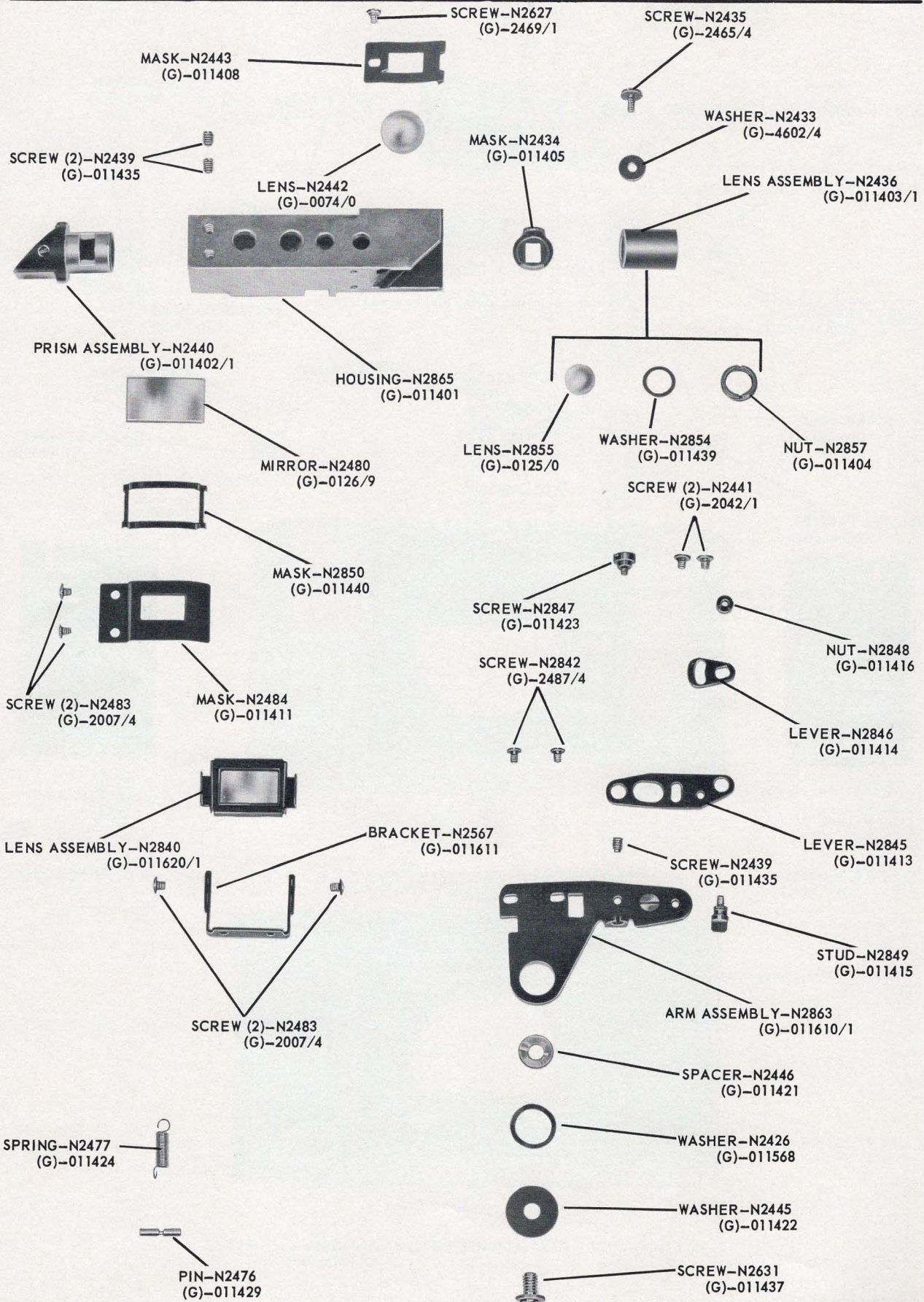

FIGURE 6

# KODAK RETINA II<sub>a</sub> CAMERA



**FIGURE 7**

# KODAK RETINA IIa CAMERA

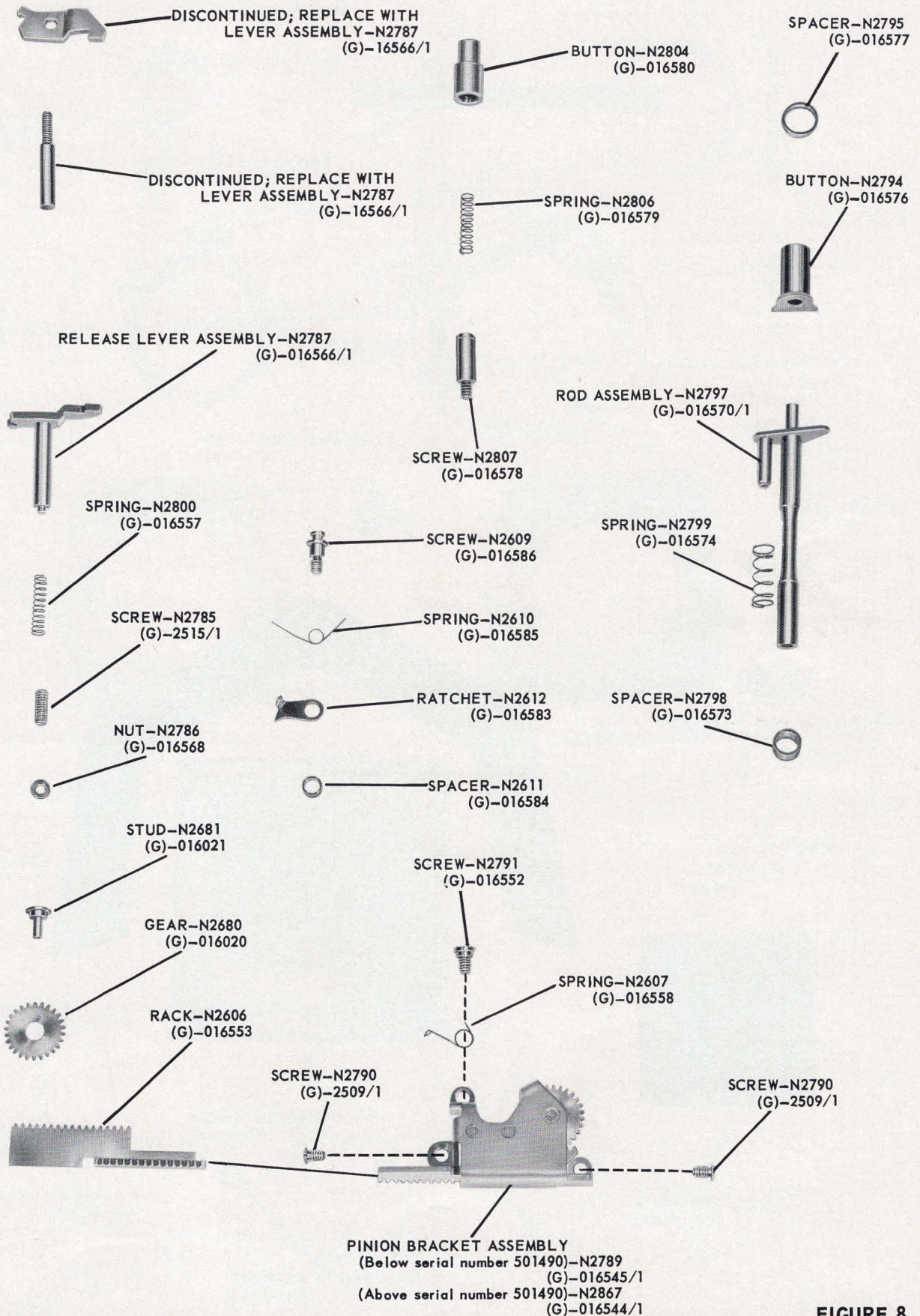

**FIGURE 8**

# KODAK RETINA IIa CAMERA

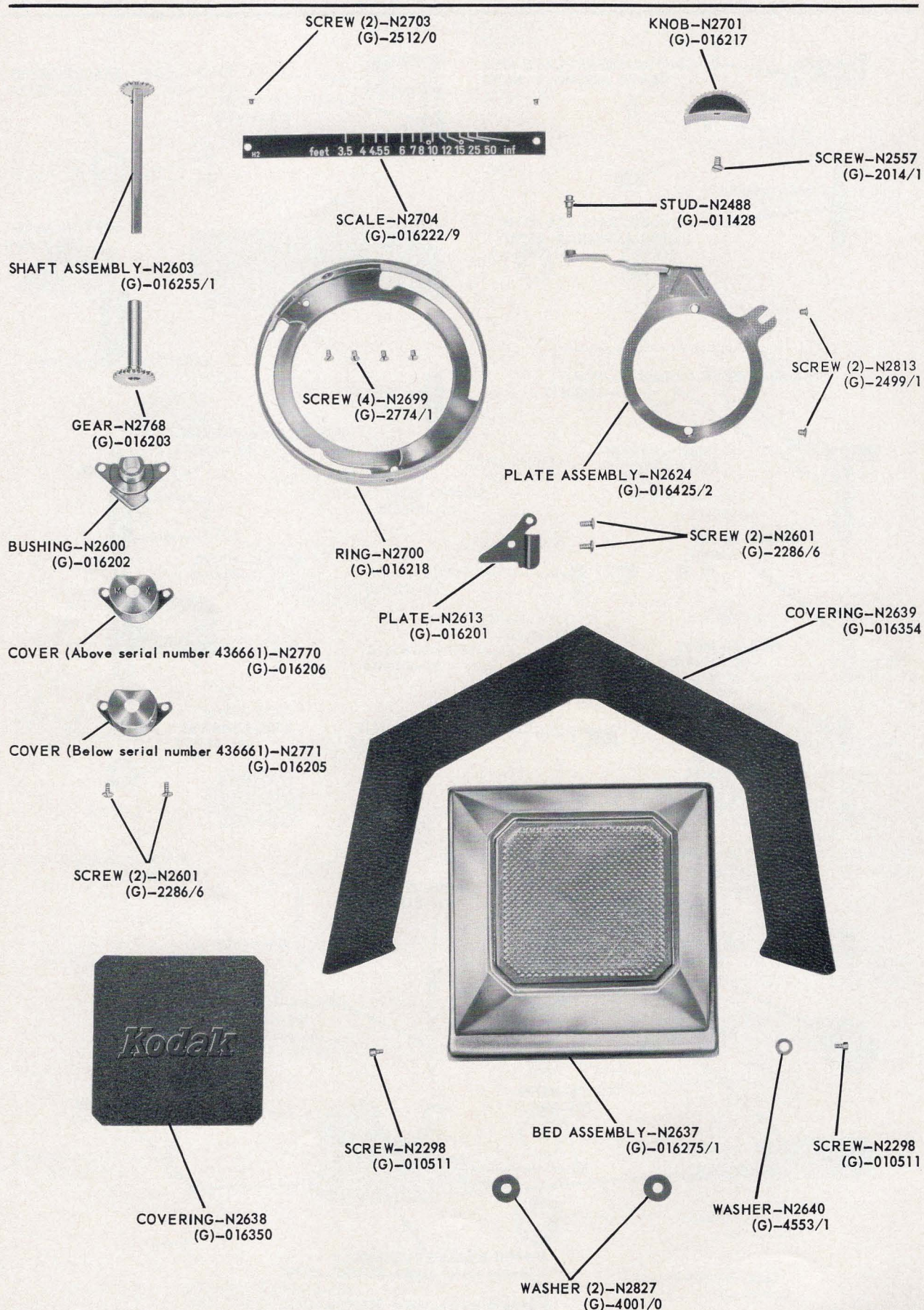

FIGURE 9



KODAK RETINA IIa CAMERA

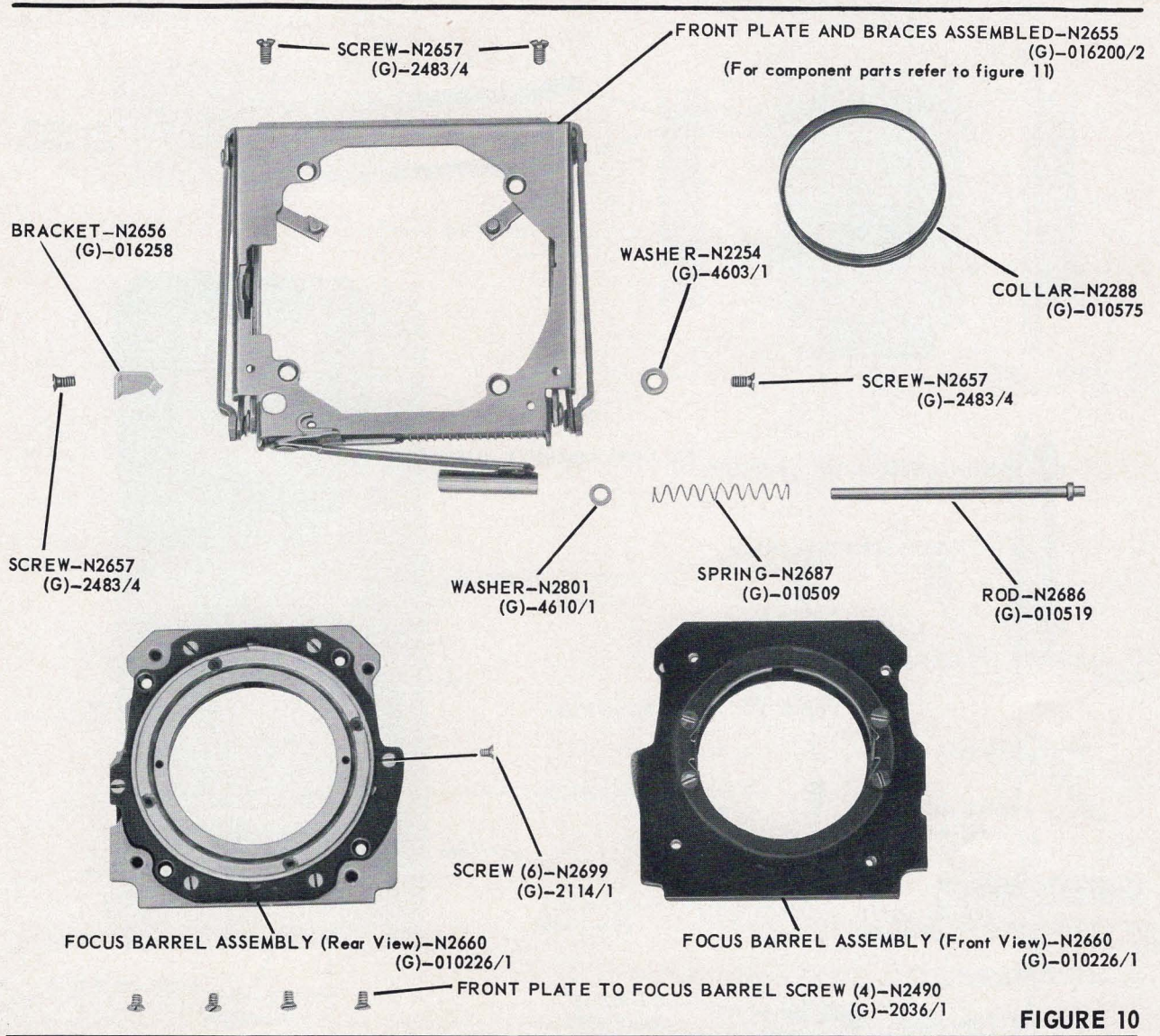

FIGURE 10

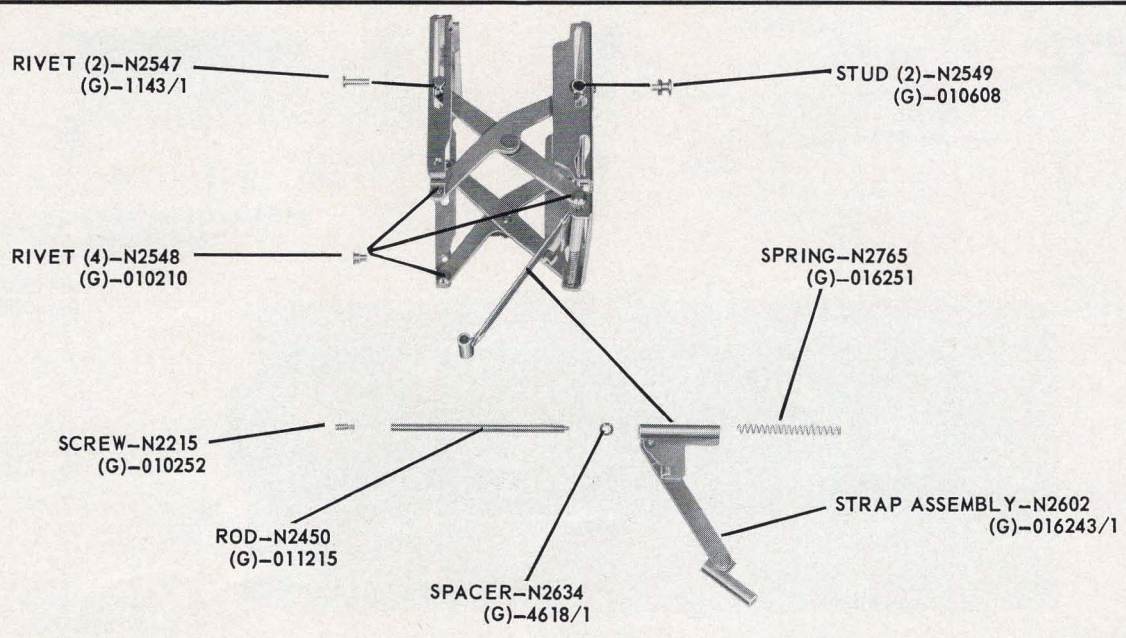

FIGURE 11

KODAK RETINA II<sub>a</sub> CAMERA

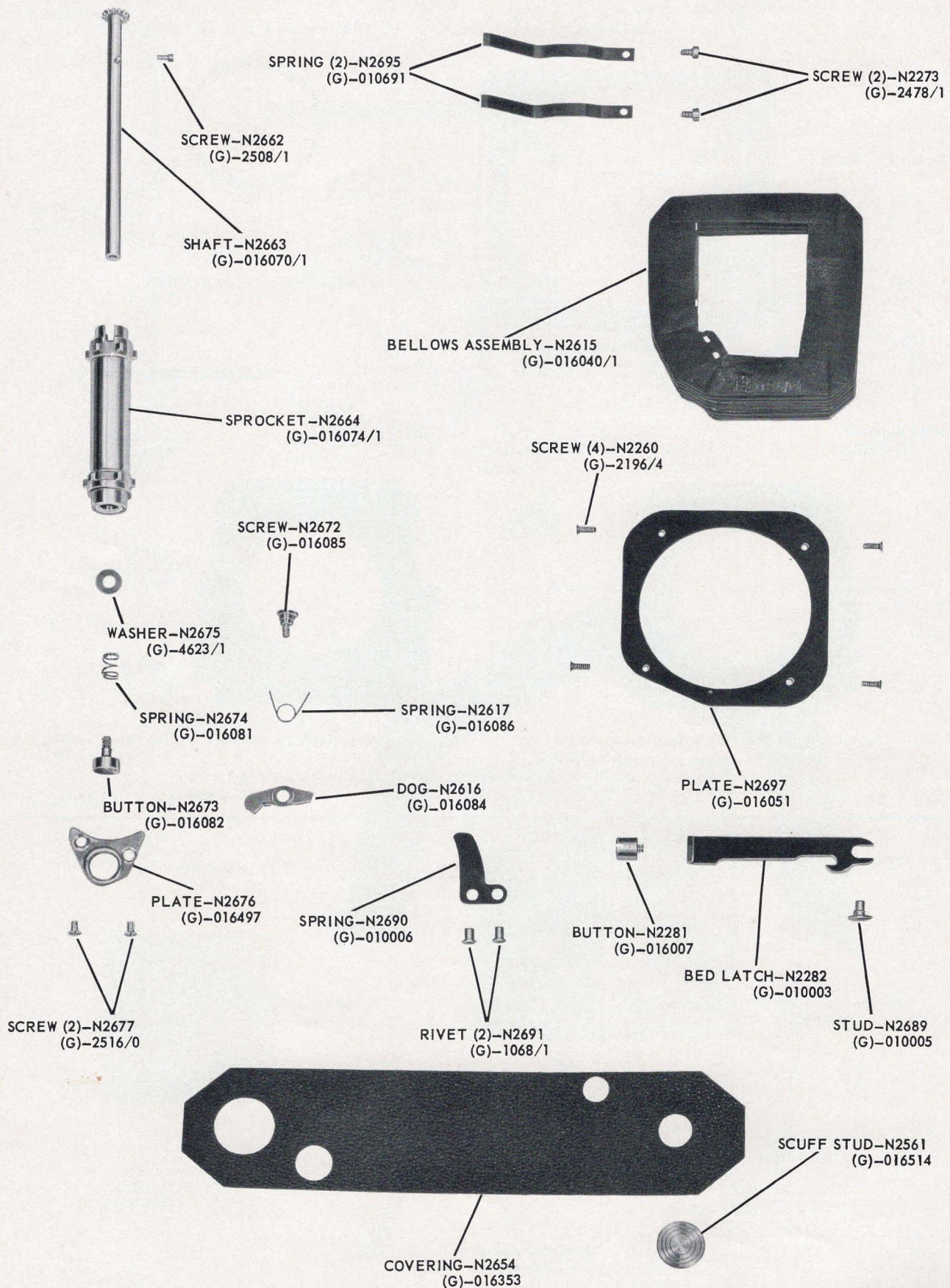

FIGURE 12

KODAK RETINA II<sub>a</sub> CAMERA

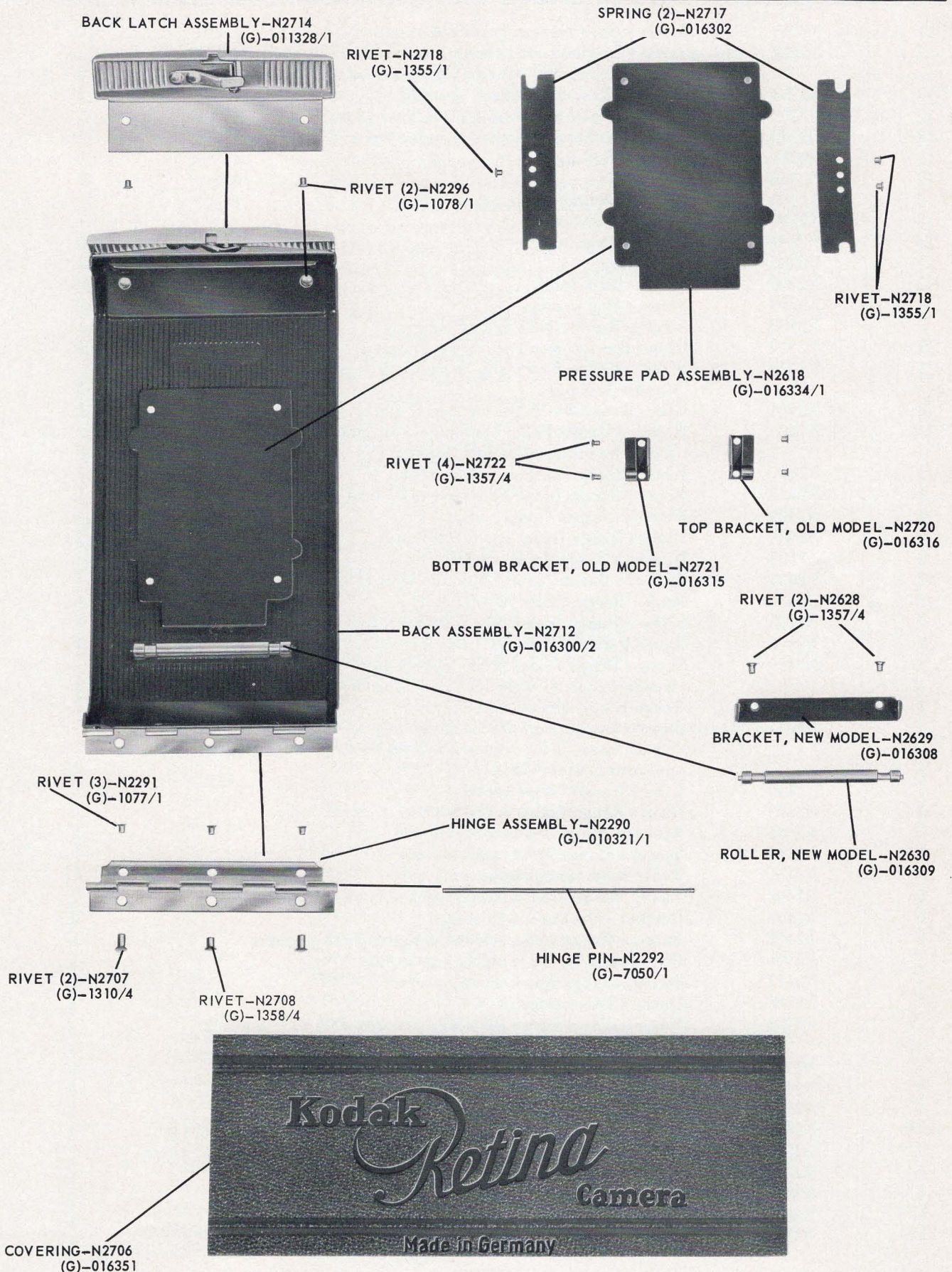

FIGURE 13

# KODAK RETINA II<sub>a</sub> CAMERA

## Numerical List

FIG.	PART NO.	PART NAME	REQD.
11	N2215	Screw - Body release guide rod	1
4,5	N2222	Screw - Rewind post bearing to case (2), Film wind shaft bushing assembly to case (3), Tripod socket to case (3)	8
10	N2254	Washer - Rear back frame, spacing	2
12	N2260	Screw - Focus barrel to front bellows plate	4
12	N2273	Screw - Bed brace throw-out spring to case	2
12	N2281	Button - Bed latch	1
12	N2282	Latch - Bed	1
10	N2288	Collar - Shutter retaining	1
13	N2290	Hinge Assembly	1
13	N2291	Rivet - Hinge to back	3
13	N2292	Pin - Hinge	1
13	N2296	Rivet - Back latch	2
9	N2298	Screw - Bed to case	2
5	N2408	Screw - Rewind post extension guide	1
5	N2410	Ring - Rewind post extension retaining	1
2	N2423	Screw - Range finder clip to mechanism cover (Below serial number 436661)	3
2	N2424	Clip - Range finder (Below serial number 436661)	1
2,7	N2426	Washer - Range finder housing eyelet lens, tension (1), Range finder movable arm, tension (1)	2
2	N2427	Lens - Range finder housing, eyelet	1
2	N2428	Mount - Range finder housing eyelet lens (nickel)	1
2	N2429	Window - Range finder, large	1
2	N2430	Plate - Range finder window retainer	1
2	N2431	Window - Range finder, small	1
7	N2433	Washer - Range finder objective lens lock screw	1
7	N2434	Mask - Range finder objective lens	1
7	N2435	Screw - Range finder objective lens, lock	1
7	N2436	Range Finder Objective Lens Assembly	1
7	N2439	Screw - Range finder prism halving adjusting (2), Range finder movable lens arm adjusting (1)	3
7	N2440	Range Finder Prism Assembly	1
7	N2441	Screw - Large range finder adjustable lever to movable arm (1), Small range finder adjustable lever to large range finder adjustable lever (1)	2
7	N2442	Lens - Range finder eyelet	1
7	N2443	Mask - Range finder eyelet lens	1
7	N2445	Washer - Range finder movable arm	1
7	N2446	Spacer - Range finder movable arm	1
11	N2450	Rod - Body release guide	1
6	N2462	Screw - Mechanism housing bracket to case, short	2
6	N2463	Bracket - Mechanism housing	2
2	N2472	Screw - Range finder window retainer plate to cover	2
7	N2476	Pin - Range finder movable arm spring	1
7	N2477	Spring - Range finder movable arm	1
7	N2480	Mirror - Transparent	1
7	N2483	Screw - Range finder movable lens assembly to bracket (2), Range finder movable lens mask to housing (2)	4
7	N2484	Mask - Range finder movable lens	1
6	N2485	Screw - Range finder to case	2
9	N2488	Stud - Actuating arm guide	1
6,10	N2490	Screw - Case to guide plate (3), Front plate to focus barrel (4)	7
1	N2540	Washer - Film indicator dial, tension (Below serial number 436661)	1
5	N2543	Bearing - Rewind post	1
5	N2544	Post - Rewind (Below serial number 436661)	1
11	N2547	Rivet - Brace to back frame	2
11	N2548	Rivet - Brace to back and front frame	4

# KODAK RETINA IIa CAMERA

## Numerical List

FIG.	PART NO.	PART NAME	REQD.
11	N2549	Stud - Brace lock	2
6,9	N2557	Screw - Neck strap bracket to case (2), Focus ring knob to focus ring (1)	3
12	N2561	Stud - Scuff	1
7	N2567	Bracket - Range finder movable lens	1
1	N2572	Film Indicator Dial Assembly (Below serial number 436661)	1
1	N2573	Nut - Film indicator dial retaining (Below serial number 436661)	1
9	N2600	Bushing - Shutter setting gear	1
9	N2601	Screw - Shutter setting gear cover and bushing to front plate (2), Bed stop plate to front plate (2)	4
11	N2602	Body Release Strap Assembly	1
9	N2603	Shutter Setting Gear and Shaft Assembly	1
4	N2604	Film Wind Clutch Assembly	1
4	N2605	Film Wind Shaft and Spring Assembly	1
8	N2606	Rack - Shutter setting	1
8	N2607	Spring - Film wind release lever	1
4	N2608	Gear - Film wind shaft pinion	1
8	N2609	Screw - Film wind ratchet	1
8	N2610	Spring - Film wind ratchet	1
8	N2611	Spacer - Film wind ratchet	1
8	N2612	Ratchet - Film wind	1
9	N2613	Plate - Bed stop, bottom	1
4	N2614	Spool - Film	1
12	N2615	Bellows Assembly	1
12	N2616	Dog - Rewind release	1
12	N2617	Spring - Rewind release	1
13	N2618	Film Pressure Pad Assembly	1
3	N2619	Dog - Winding lever lock	1
1	N2620	Exposure Indicator Spring Assembly	1
1	N2621	Screw - Exposure counter retaining	1
9	N2624	Range Finder Actuating Plate Assembly	1
6	N2625	Plate - Range finder actuating lever guide	1
1	N2626	Film Indicator Dial Assembly (Between serial numbers 436661 and 480450)	1
7	N2627	Screw - Range finder eyelet lens mask	1
13	N2628	Rivet - Film roller bracket to back	2
13	N2629	Bracket - Film roller, new model	1
13	N2630	Roller - Film, new model	1
7	N2631	Screw Range finder movable arm to housing	1
11	N2634	Washer - Body release strap, spacing	1
3	N2635	Plate - Film wind lever dog cover	1
9	N2637	Bed	1
9	N2638	Covering - Bed, center	1
9	N2639	Covering - Bed, outside	1
9	N2640	Washer - Bed to case, spacing	1
5	N2649	Extension - Rewind post (Below serial number 543235)	1
5	N2650	Post - Rewind (Between serial numbers 436661 and 543235)	1
12	N2654	Covering - Case, bottom	1
10	N2655	Front Plate and Braces Assembled	1
10	N2656	Bracket - Shutter setting gear	1
10	N2657	Screw - Case to rear back frame	1
10	N2660	Focus Barrel Assembly	4
12	N2662	Screw - Sprocket shaft	1
12	N2663	Shaft - Film sprocket	1
12	N2664	Sprocket - Film	1
1,2	N2665	Mechanism Cover Assembly (Below serial number 436661)	1
6	N2666	Case Assembly	1
6	N2668	Covering - Case, left	1

Always give PART NUMBER and NAME when ordering parts

KODAK RETINA IIa CAMERA

Numerical List

FIG.	PART NO.	PART NAME	REQD.
6	N2669	Covering - Case, right	1
12	N2672	Screw - Rewind dog	1
12	N2673	Button - Rewind Release	1
12	N2674	Spring - Rewind release button	1
12	N2675	Washer - Rewind release button spring	1
12	N2676	Plate - Rewind release button retaining	1
4,12	N2677	Screw - Rewind release button retaining plate to case (2), Film wind shaft and spring assembly to case (3)	5
8	N2680	Gear - Shutter setting shaft pinion	1
8	N2681	Stud - Shutter setting shaft pinion gear	1
6	N2682	Bracket - Neck strap, right	1
6	N2683	Bracket - Neck strap, left	1
6	N2684	Rivet - Neck strap bracket to case	2
10	N2686	Rod - Body release guide	1
10	N2687	Spring - Body release guide rod	1
6	N2688	Stud - Back latch	1
12	N2689	Stud - Bed release guide	1
12	N2690	Spring - Bed release	1
12	N2691	Rivet - Bed release spring to case	2
12	N2695	Spring - Bed brace throw-out	2
12	N2697	Plate - Bellows, front	1
9,10	N2699	Screw - Focus ring to focus barrel retaining (4), Retaining plate to focus barrel housing (6)	10
9	N2700	Ring - Focus	1
9	N2701	Knob - Focus ring	1
9	N2703	Screw - Footage scale	2
9	N2704	Scale - Footage	1
13	N2706	Covering - Back	1
13	N2707	Rivet - Hinge to case, long	2
13	N2708	Rivet - Hinge to case, short	1
13	N2712	Back Assembly	1
13	N2714	Back Latch Assembly	1
13	N2717	Spring - Film pressure pad	2
13	N2718	Rivet - Film pressure pad spring to back	3
13	N2720	Bracket - Film guide, top, old model	1
13	N2721	Bracket - Film guide, bottom, old model	1
13	N2722	Rivet - Film guide bracket, old model	4
1	N2723	Ring - Film indicator pointer (Above serial number 436661)	1
1	N2724	Washer - Film indicator pointer tension (Above serial number 436661)	1
1	N2726	Screw - Film indicator retaining (Above serial number 436661)	1
1	N2727	Sleeve - Rewind post (Between serial numbers 436661 and 480450)	1
2	N2729	Clip - Range finder (Above serial number 436661)	1
2	N2730	Screw - Range finder clip (Above serial number 436661)	3
1	N2731	Screw - Mechanism cover to mechanism housing bracket	2
1,2	N2732	Mechanism Cover Assembly (Between serial numbers 436661 and 501490)	1
2	N2734	Stud - Film wind lever stop	1
1	N2735	Winding Lever Assembly	1
3	N2737	Spring - Winding lever lock dog	1
3	N2739	Screw - Film wind lever dog cover plate to winding lever	2
3	N2740	Covering - Winding lever	1
1	N2741	Ring - Exposure counter setting	1
1	N2742	Dial - Exposure	1
1	N2743	Ratchet - Exposure counter	1
1	N2744	Washer - Exposure counter ratchet, tension	1

## KODAK RETINA IIa CAMERA

## Numerical List

FIG.	PART NO.	PART NAME	REQD.
1	N2745	Ring - Exposure counter pointer	1
1	N2746	Lockwasher - Exposure counter retaining screw	1
4	N2749	Spacer - Film wind shaft pinion gear	1
1	N2757	Knob - Rewind (Below serial number 436661)	1
1	N2758	Sleeve - Rewind post (Below serial number 436661)	1
6	N2763	Range Finder Complete	1
11	N2765	Spring - Body release	1
9	N2768	Gear - Shutter setting	1
9	N2770	Cover - Shutter setting gear (Above serial number 436661)	1
9	N2771	Cover - Shutter setting gear (Below serial number 436661)	1
4	N2777	Spring - Film wind	1
4	N2778	Pawl - Film wind	1
4	N2779	Ratchet and Drive Gear Assembly	1
4	N2780	Film Wind Shaft Bushing Assembly	1
4	N2783	Bearing - Film spool	1
4	N2784	Winding Key Cam Assembly	1
8	N2785	Screw - Film wind release	1
8	N2786	Nut - Film wind release screw	1
8	N2787	Film Wind Release Lever Assembly	1
8	N2789	Pinion Bracket and Rack Assembly (Below serial number 501490)	1
8	N2790	Screw - Pinion bracket assembly to case	2
8	N2791	Screw - Pinion bracket assembly to case, shoulder	1
8	N2794	Button - Body release	1
8	N2795	Spacer - Body release button	1
8	N2797	Body Release Push Rod Assembly	1
8	N2798	Spacer - Body release push rod	1
8	N2799	Spring - Body release push rod	1
8	N2800	Spring - Film wind release lever	1
10	N2801	Washer - Body release guide rod, spacing	1
8	N2804	Button - Film wind release lever	1
8	N2806	Spring - Film wind release lever button	1
8	N2807	Screw - Film wind release guide	1
6	N2808	Screw - Mechanism housing bracket to case, long	2
9	N2813	Screw - Actuating plate to focus tube	2
9	N2827	Washer - Bed spacing	2
7	N2840	Range Finder Movable Lens Assembly	1
7	N2842	Screw - Range finder movable lens bracket to arm	2
7	N2845	Lever - Range finder adjustable, large	1
7	N2846	Lever - Range finder adjustable, small	1
7	N2847	Screw - Large range finder adjustable arm pivot	1
7	N2848	Nut - Range finder to actuating arm stud	1
7	N2849	Stud - Range finder to actuating arm	1
7	N2850	Mask - Transparent mirror, tension	1
7	N2854	Washer - Range finder objective lens	1
7	N2855	Lens - Range finder objective	1
7	N2857	Nut - Range finder objective lens	1
7	N2863	Range Finder Movable Lens Arm Assembly	1
7	N2865	Housing - Range finder	1
1,2	N2866	Cover Assembly (Above serial number 501490)	1
8	N2867	Pinion Bracket and Rack Assembly (Above serial number 501490)	1
4	N2868	Socket - Tripod (Below serial number 543235)	1
4	N2869	Socket - Tripod (Above serial number 543235)	1
4	N2870	Ring - Tripod socket (Above serial number 543235)	1
4	N2871	Screw - Tripod socket ring (Above serial number 543235)	1
1	N2876	Sleeve (Above serial number 480450)	1
1	N2877	Mount - Range finder housing eyelet lens (black)	1

**KODAK SYNCHRO-COMPUR SHUTTER**  
and  
**KODAK COMPUR-RAPID SHUTTER (FLASH MODEL)**

FRONT LENS ASSEMBLY – THIS PART CANNOT BE  
PROCURED SEPARATELY ORDER 1 SET OF LENSES  
(FRONT AND REAR ASSEMBLIES)–N2900  
(G)–016860

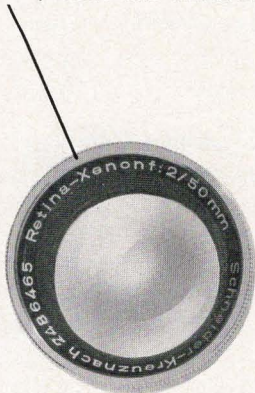

SPACER–N2581  
(G)–014675

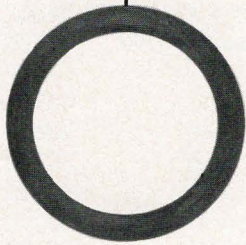

PLATE ASSEMBLY–N2901  
KODAK SYNCHRO-COMPUR SHUTTER

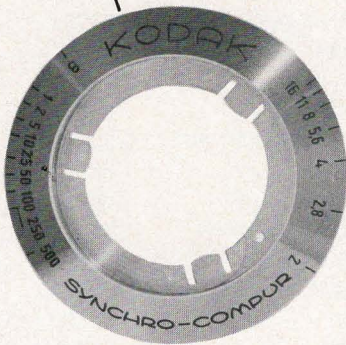
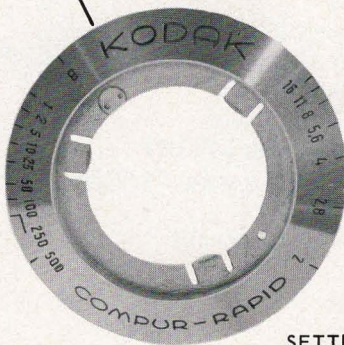
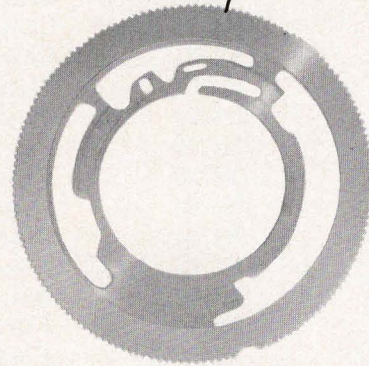

PLATE ASSEMBLY–N2902  
(G)–CR00-338/540  
Kodak Compur-Rapid Shutter (Flash Model)



SPEED CAM – KODAK SYNCHRO-COMPUR SHUTTER  
(The shutter manufacturer will not furnish this item as a  
replaceable part. Return the shutter to us for repair.)



SPEED CAM – KODAK COMPUR-RAPID SHUTTER (FLASH MODEL)  
(The shutter manufacturer will not furnish this item as a replaceable  
part. Return the shutter to us for repair.)

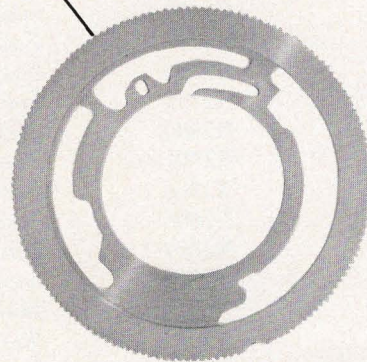

SETTING LEVER ASSEMBLY–N2905  
KODAK SYNCHRO-COMPUR SHUTTER

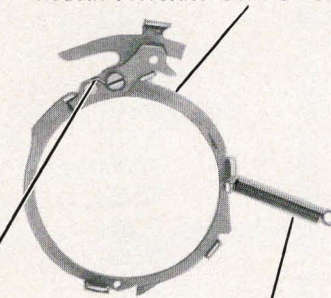

SPRING–N2907

SPRING–N1105

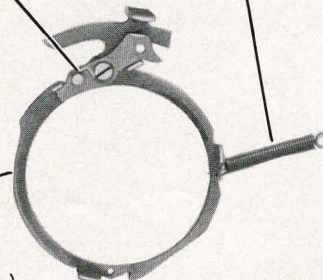

SETTING LEVER ASSEMBLY–N2906  
KODAK COMPUR-RAPID SHUTTER (FLASH MODEL)

**FIGURE 14**



**KODAK SYNCHRO-COMPUR SHUTTER  
and  
KODAK COMPUR-RAPID SHUTTER (FLASH MODEL)**

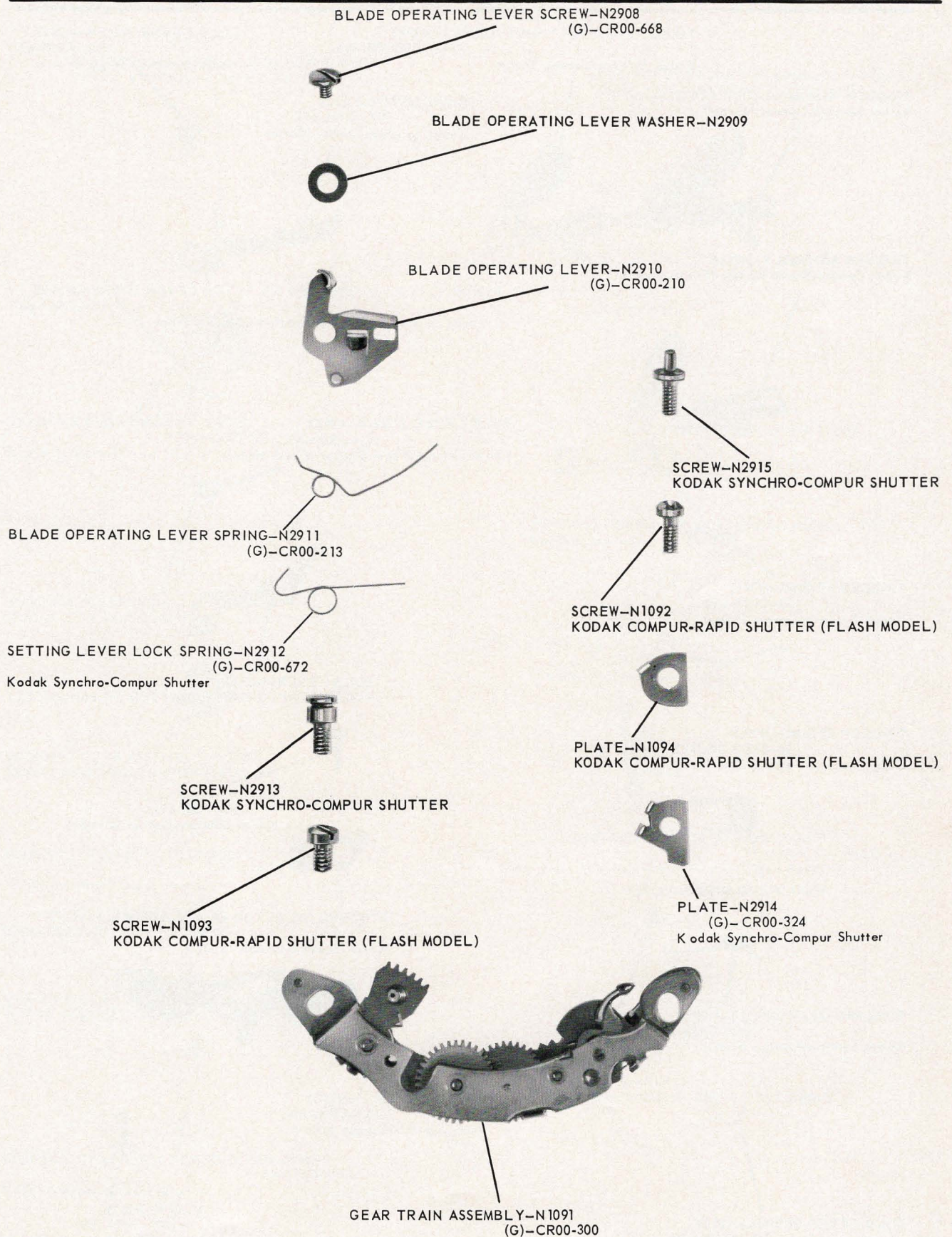

**FIGURE 15**

**KODAK SYNCHRO-COMPUR SHUTTER  
and  
KODAK COMPUR-RAPID SHUTTER (FLASH MODEL)**

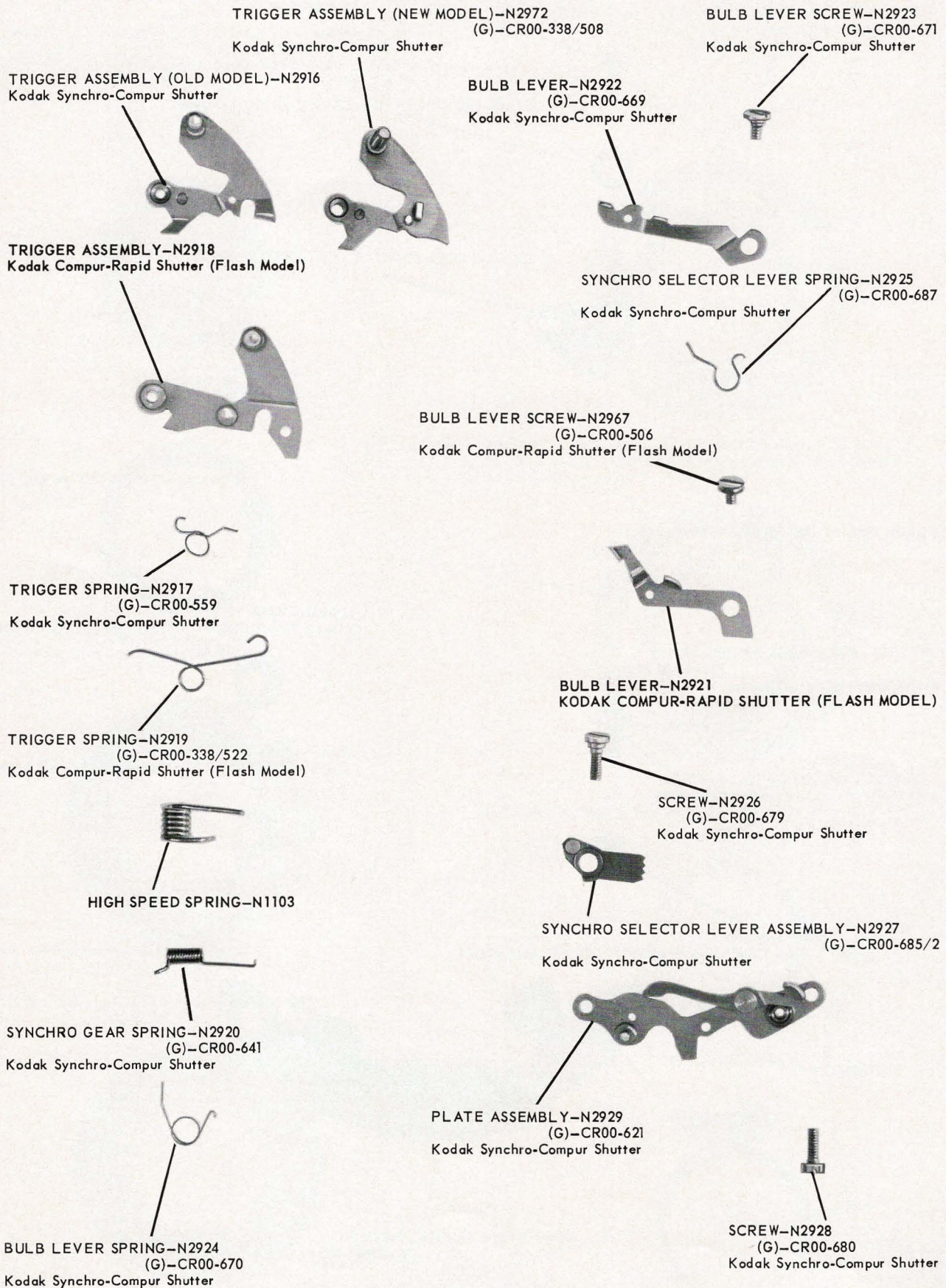

**FIGURE 16**

**KODAK SYNCHRO-COMPUR SHUTTER  
and  
KODAK COMPUR-RAPID SHUTTER (FLASH MODEL)**

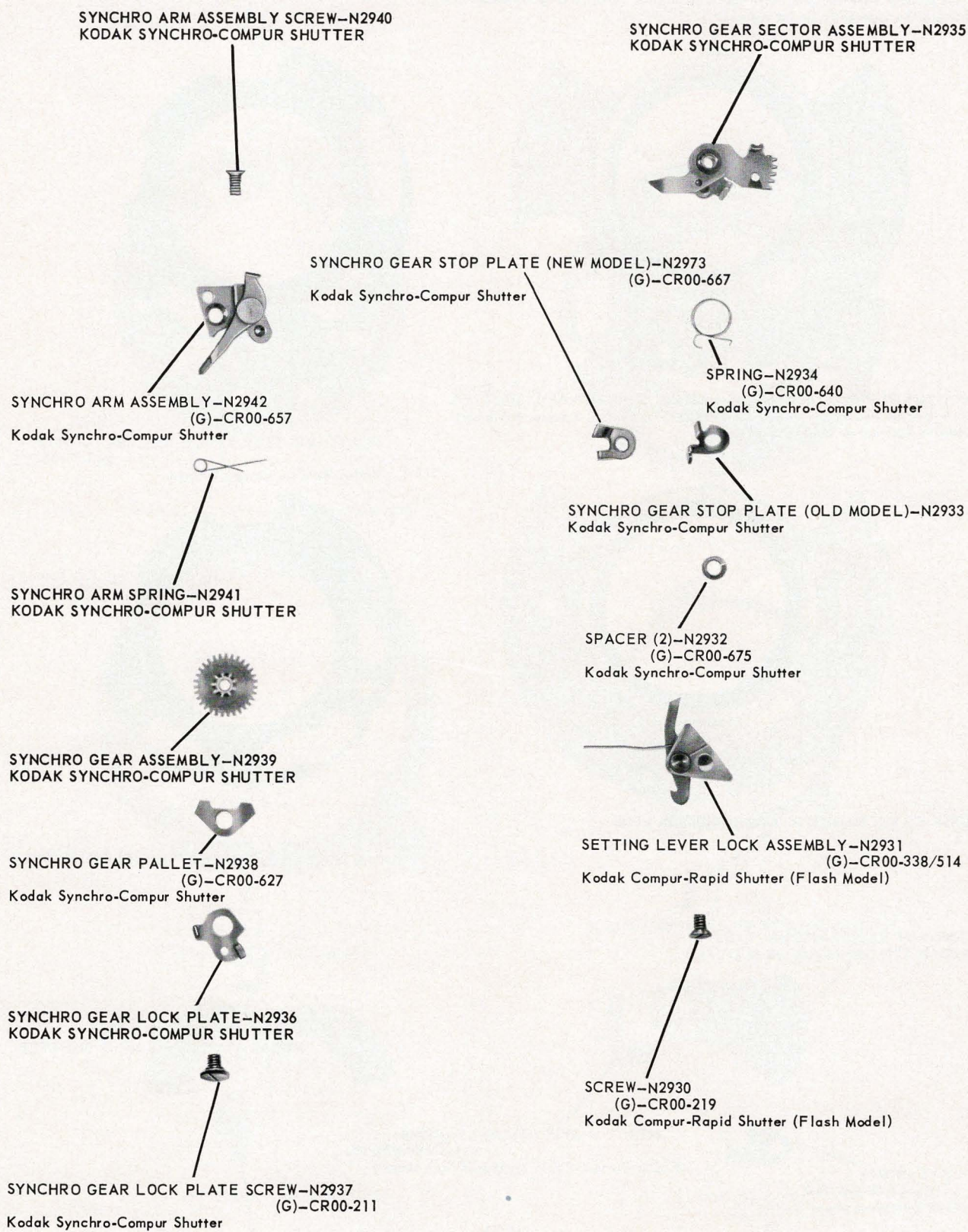

**FIGURE 17**

**KODAK SYNCHRO-COMPUR SHUTTER  
and  
KODAK COMPUR-RAPID SHUTTER (FLASH MODEL)**

**MECHANISM PLATE ASSEMBLY – KODAK SYNCHRO-COMPUR SHUTTER**  
(The shutter manufacturer will not furnish this item as a replaceable part.  
Return the shutter to us for repair.)

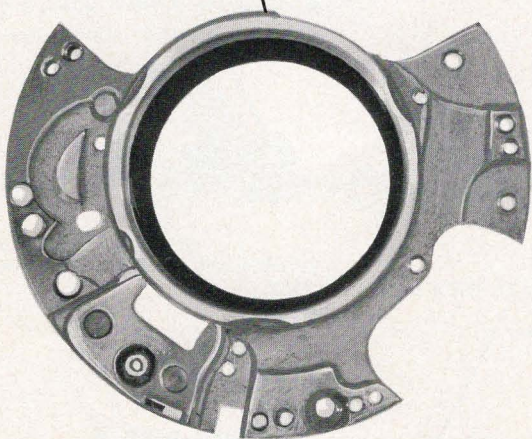

SCREW (4)–N1090



PLATE AND STAR WHEEL ASSEMBLY–N2943  
(G)–CR00-225  
Kodak Synchro-Compur Shutter

**MECHANISM PLATE ASSEMBLY – KODAK COMPUR-RAPID SHUTTER**  
(The shutter manufacturer will not furnish this item as a replaceable part.  
Return the shutter to us for repair.)

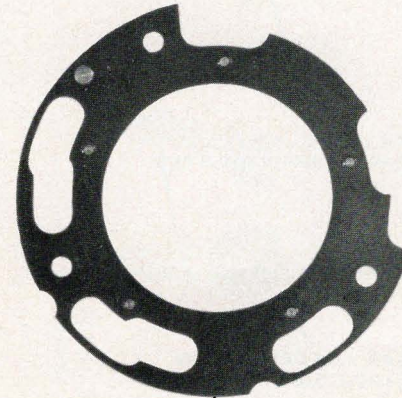
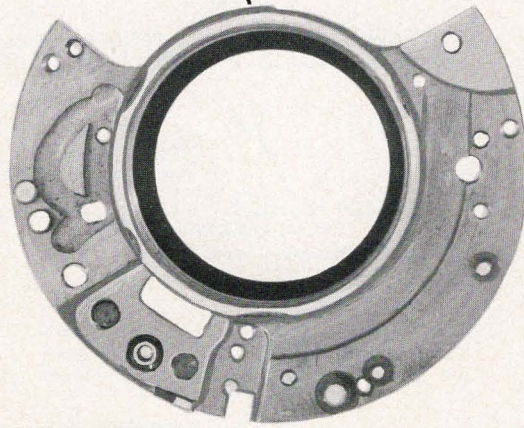
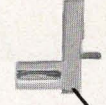
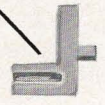

PLATE ASSEMBLY–N2532  
KODAK COMPUR-RAPID SHUTTER (FLASH MODEL)

CASE TO MECHANISM PLATE SCREW (3)–N380



CONTACT BLOCK ASSEMBLY–N2945  
KODAK SYNCHRO-COMPUR SHUTTER



CONTACT BLOCK ASSEMBLY–N2948  
(G)–CR00-826/601  
Kodak Compur-Rapid Shutter (Flash Model)

PLATE–N2946  
(G)–CR00-826/604  
Kodak Synchro-Compur Shutter



SYNCHRO CONTACT–N2944  
KODAK SYNCHRO-COMPUR SHUTTER



FLASH CONTACT–N2947  
KODAK COMPUR-RAPID SHUTTER (FLASH MODEL)

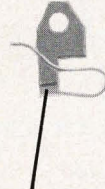

CONTACT BLOCK TO MECHANISM PLATE SCREW–N2968  
(G)–CR00-826/612



**FIGURE 18**

KODAK SYNCHRO-COMPUR SHUTTER  
and  
KODAK COMPUR-RAPID SHUTTER (FLASH MODEL)

SCREW (2)-N1076



SCREW (3)-N1080  
(G)-CR00-117

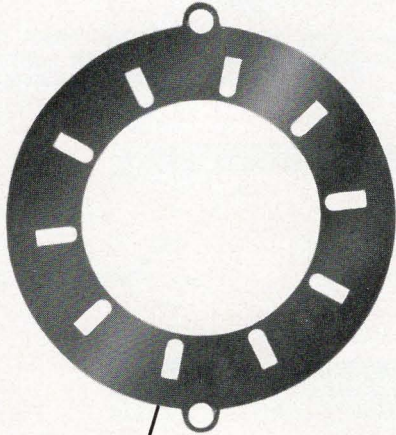

DIAPHRAGM CONTROL PLATE-N1075

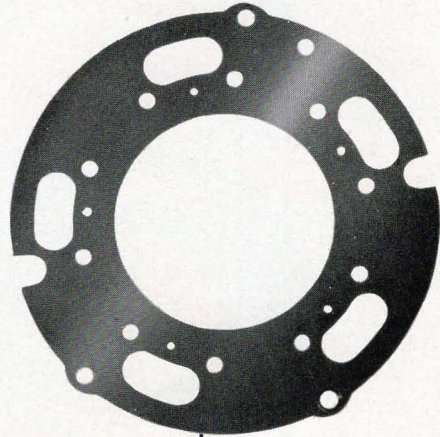

DIAPHRAGM RETAINER PLATE-N2578



DIAPHRAGM RING-N2952

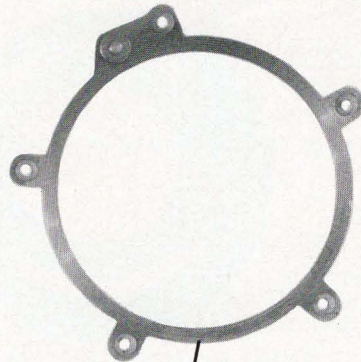

BLADE CONTROLLER ASSEMBLY-N2951

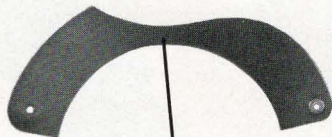

DIAPHRAGM WING (10)-N1074



BLADE (5)-N1084  
(G)-CR00-208/6

FIGURE 19

**KODAK SYNCHRO-COMPUR SHUTTER  
and  
KODAK COMPUR-RAPID SHUTTER (FLASH MODEL)**

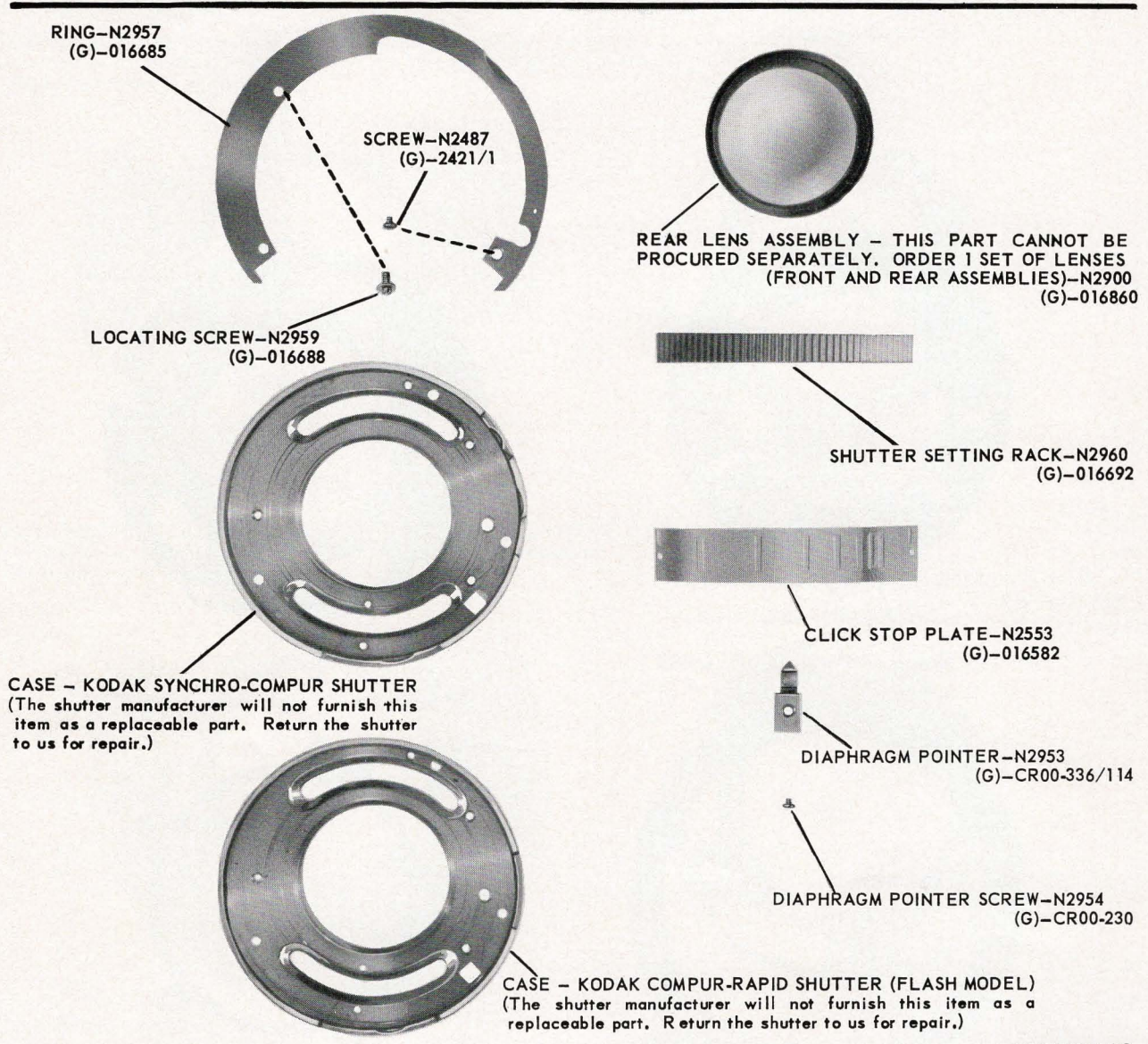

**FIGURE 20**

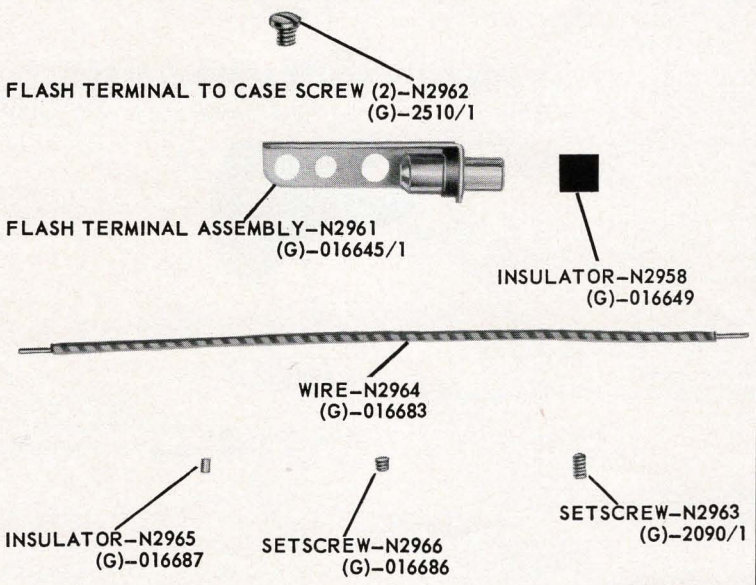

**FIGURE 21**



**FIGURE 22**

**KODAK SYNCHRO-COMPUR SHUTTER**  
and  
**KODAK COMPUR-RAPID SHUTTER (FLASH MODEL)**

Numerical List

FIG.	PART NO.	PART NAME	REQD.
		Kodak Flashpost Adapter	1
22			3
18	N380	Screw - Case to mechanism plate	10
19	N1074	Wing - Diaphragm	1
19	N1075	Plate - Diaphragm control	2
19	N1076	Screw - Diaphragm control plate to diaphragm ring	3
19	N1080	Screw - Diaphragm retainer plate	5
19	N1084	Blade - Shutter	4
18	N1090	Screw - Blade retainer plate	1
15	N1091	Gear Train Assembly	
15	N1092	Screw - Gear train assembly to mechanism plate (Kodak Compur-Rapid Shutter Flash Model)	1
15	N1093	Screw - Gear train assembly to mechanism plate (Kodak Compur-Rapid Shutter Flash Model)	1
15	N1094	Plate - Setting spring anchor (Kodak Compur-Rapid Shutter Flash Model)	1
16	N1103	Spring - High speed	1
14	N1105	Spring - Setting lever	1
20	N2487	Screw - Depth of field indicator ring to case	1
18	N2532	Blade Retainer Plate Assembly (Kodak Compur-Rapid Shutter Flash Model)	1
20	N2553	Plate - Click stop	1
19	N2578	Plate - Diaphragm retainer	1
14	N2581	Spacer - Front lens assembly to speed and diaphragm index plate	1
14,20	N2900	Lenses (Front and Rear Assemblies)	1 set
14	N2901	Speed and Diaphragm Index Plate Assembly (Kodak Synchro-Compur Shutter)	1
14	N2902	Speed and Diaphragm Index Plate Assembly (Kodak Compur-Rapid Shutter Flash Model)	1
14	N2905	Setting Lever Assembly (Kodak Synchro-Compur Shutter)	1
14	N2906	Setting Lever Assembly (Kodak Compur-Rapid Flash Shutter)	1
14	N2907	Spring - Opening lever	1
15	N2908	Screw - Blade operating lever	1
15	N2909	Washer - Blade operating lever	1
15	N2910	Lever - Blade operating	1
15	N2911	Spring - Blade operating lever	1
15	N2912	Spring - Setting lever lock (Kodak Synchro-Compur Shutter)	1
15	N2913	Screw - Gear train assembly to mechanism plate (Kodak Synchro-Compur Shutter)	1
15	N2914	Plate - Setting lever spring and synchro spring anchor (Kodak Synchro-Compur Shutter)	1
15	N2915	Screw - Gear train assembly to mechanism plate (Kodak Synchro-Compur Shutter)	1
16	N2916	Trigger Assembly, Old Model (Kodak Synchro-Compur Shutter)	1
16	N2917	Spring - Trigger (Kodak Synchro-Compur Shutter)	1
16	N2918	Trigger Assembly (Kodak Compur-Rapid Shutter Flash Model)	1
16	N2919	Spring - Trigger (Kodak Compur-Rapid Shutter Flash Model)	1
16	N2920	Spring - Synchro gear (Kodak Synchro-Compur Shutter)	1
16	N2921	Lever - Bulb (Kodak Compur-Rapid Shutter Flash Model)	1
16	N2922	Lever - Bulb (Kodak Synchro-Compur Shutter)	1
16	N2923	Screw - Bulb lever (Kodak Synchro-Compur Shutter)	1
16	N2924	Spring - Bulb lever (Kodak Synchro-Compur Shutter)	1
16	N2925	Spring - Synchronizer selector lever (Kodak Synchro-Compur Shutter)	1
16	N2926	Screw - Synchronizer selector lever (Kodak Synchro-Compur Shutter)	1
16	N2927	Synchronizer Selector Lever Assembly (Kodak Synchro-Compur Shutter)	1
16	N2928	Screw - Synchro gear cover plate assembly to mechanism plate (Kodak Synchro-Compur Shutter)	1

**KODAK SYNCHRO-COMPUR SHUTTER**  
and  
**KODAK COMPUR-RAPID SHUTTER (FLASH MODEL)**

Numerical List

FIG.	PART NO.	PART NAME	REQD.
16	N2929	Setting Lever Lock and Synchro Gear Cover Plate Assembly (Kodak Synchro-Compur Shutter)	1
17	N2930	Screw - Setting lever lock assembly to mechanism plate (Kodak Compur-Rapid Shutter Flash Model)	1
17	N2931	Setting Lever Lock Assembly (Kodak Compur-Rapid Shutter Flash Model)	1
17	N2932	Spacer - Synchro gear stop plate (Kodak Synchro-Compur Shutter)	2
17	N2933	Plate - Synchro gear stop, Old Model (Kodak Synchro-Compur Shutter)	1
17	N2934	Spring - Synchro gear stop plate (Kodak Synchro-Compur Shutter)	1
17	N2935	Synchro Gear Sector Assembly (Kodak Synchro-Compur Shutter)	1
17	N2936	Plate - Synchro gear lock (Kodak Synchro-Compur Shutter)	1
17	N2937	Screw - Synchro gear lock plate to mechanism plate (Kodak Synchro-Compur Shutter)	1
17	N2938	Pallet - Synchro gear (Kodak Synchro-Compur Shutter)	1
17	N2939	Synchro Gear Assembly (Kodak Synchro-Compur Shutter)	1
17	N2940	Screw - Synchro arm assembly to mechanism plate (Kodak Synchro-Compur Shutter)	1
17	N2941	Spring - Synchro arm (Kodak Synchro-Compur Shutter)	1
17	N2942	Synchro Arm Assembly (Kodak Synchro-Compur Shutter)	1
18	N2943	Blade Retainer Plate and Star Wheel Assembly (Kodak Synchro-Compur Shutter)	1
18	N2944	Contact - Synchro (Kodak Synchro-Compur Shutter)	1
18	N2945	Synchro Contact Block Assembly (Kodak Synchro-Compur Shutter)	1
18	N2946	Plate - Synchro contact block (Kodak Synchro-Compur Shutter)	1
18	N2947	Contact - Flash (Kodak Compur-Rapid Shutter Flash Model)	1
18	N2948	Contact Block Assembly (Kodak Compur-Rapid Shutter Flash Model)	1
19	N2951	Blade Controller Assembly	1
19	N2952	Ring - Diaphragm	1
20	N2953	Pointer - Diaphragm	1
20	N2954	Screw - Diaphragm pointer	1
20	N2957	Ring - Depth of field indicator	1
21	N2958	Insulator - Flash terminal	1
20	N2959	Screw - Shutter locating (Kodak Synchro-Compur Shutter)	1
20	N2960	Rack - Shutter setting	1
21	N2961	Flash Terminal Assembly	1
21	N2962	Screw - Flash Terminal to case	2
21	N2963	Setscrew - Wire to flash terminal	1
21	N2964	Wire	1
21	N2965	Insulator	1
21	N2966	Setscrew - Wire to contact block	1
16	N2967	Screw - Bulb lever (Kodak Compur-Rapid Shutter Flash Model)	1
18	N2968	Screw - Contact block to mechanism plate	1
16	N2972	Trigger Assembly, New Model (Kodak Synchro-Compur Shutter)	1
17	N2973	Plate - Synchro gear stop, New Model (Kodak Synchro-Compur Shutter)	1

Always give PART NUMBER and NAME when ordering parts

**EASTMAN KODAK COMPANY • ROCHESTER 4, N. Y.**