

NOVOFLEX

CATALOGUE

NOVOFLEX

1978

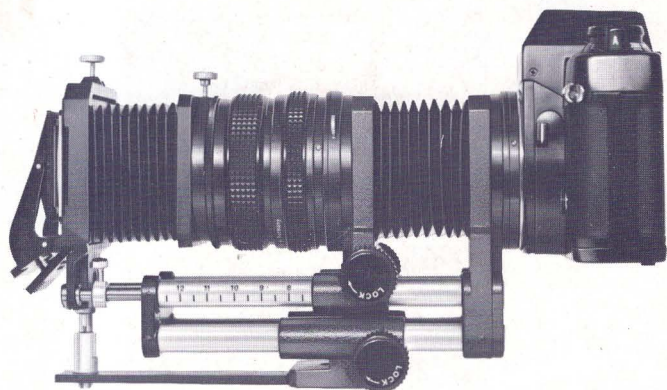

TELE
MACRO
REPRO
MICRO
WIDE-ANGLE

Photography

with S. L. R. Cameras

Complete Follow Focus Lenses with

Camera Adaptor COA etc.

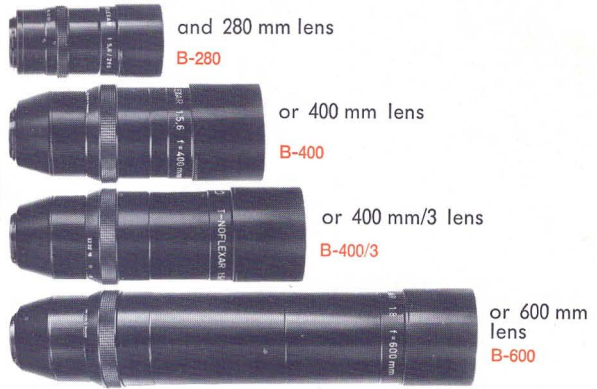

		280 mm		400 mm		400 mm/3		600 mm	
		with BA or BAL-U:		with BA or BAL-U:		with BA or BAL-U:		with BA or BAL-U:	
		with BA	BAL-U	with BA	BAL-U	with BA	BAL-U	with BA	BAL-U
Please specify: Code + Focal Length + B (for BA) or U (for BAL-U) e.g. COPI-280-B									
Camera	Code	-280-B	-280-U	-400-B	-400-U	-400/3-B	-400/3-U	-600-B	-600-U
M 42 x 1	COPI-								
Contax RTS () Yashica FX () Exakta, Exa II Exakta Twin TL Konica Leica R3, Leicaflex SL Minolta SR Miranda Nikon Asahi Pentax K, M Praktina Rolleiflex-SL-35(0) Topcon SR Zenit (39 φ)	CONTPI- AUXPI- TWINPI- KONIPI- LERPI- MINPI- MIRPI- NIKPI- PENTPI- PRAPI- ROLPI- IXPI- ZENPI-								
Alpa Canon Contarex Icarex BM Olympus OM Pentriplex	ALPI- CANPI- REXPI- ICAPI- OMPI- PEPI-								
Visoflex II/III	VISPI-	With Adaptor VISBA for Leica + Visoflex (Focusing to infinity would NOT be possible with "VISA + BA")							
Leicina Special	VISPI LERPI MINPI COPI	Leicina Special can be used with the following lens combinations with adaptors purchased only from Leitz: + Leitz Adaptor No. 543 195: Leicina S to M bayonet lenses + Leitz Adaptor No. 22 228: Leicina S to Leicaflex lenses + Leitz Adaptor No. 22 233: Leicina S to Minolta lenses + Leitz Adaptor No. 22 232: Leicina S to M 42 x 1 (Praktica etc.) lenses							
Arriflex (w. Adapt. ARBA) Beaulieu Super 8	ARPI- BEAPI-S-								
Beaulieu 16 mm Bolex RX 8 mm, 16 mm Pathé Webó	BEAPI-16- BOLPI- WEBPI-	ditto + Cradle Support:							

Focal length	with	Focusing Range	Ratio of Reproduction	Size of subject, frame-filling
280 mm	PIGRIFF-B	4.20 m - ∞		
280 mm	+ BAL-U	1.05 m - ∞	1 : 2.5	6 x 9 cm
400 mm	PIGRIFF-B	8.20 m - ∞		
400 mm	+ BAL-U	1.90 m - ∞	1 : 3	8 x 12 cm
600 mm	PIGRIFF-B	16.60 m - ∞		
600 mm	+ BAL-U	4.00 m - ∞	1 : 5	12 x 18 cm

Components

to make up Follow Focus lenses (listed complete on page 2)

Universal Novoflex Camera Adaptors

Example: COA + BA + PIGRIFF-B + B-280 = COPI-280-B

COA + BAL-U + PIGRIFF-B + B-280 = COPI-280-U

for use of the below-mentioned cameras with BA, BAL-U

(and with the bellows on page 8:

BAL-S, BALCAST serve other uses than with PIGRIFF-B)

COA
CONTA
AUXA
TWINA
KONIA
LEA-R
MINA
MIRA
NIKA
PENTA
PRAA
ROLA
IXA
ZENA
ALA
CANA
REXA
ICAA
OMA
PEA

with M 42 x 1 threads (Praktica etc.)

Contax RTS, Yashica FX

Exakta, Exa II

Exakta Twin TL

Konica

Leicaflex SL, Leica R 3

Minolta

Miranda

Nikon

Asahi Pentax K, M

Praktina

Rolleiflex-SL-35, SL-350

Topcon SR, Exa(kt)a II, Topcon, Mamiya Reflex

Zenit (39 φ)

Alpa

Canon

Contarex

Icarex BM

Olympus OM

Petriflex

The above adaptors – when used with Follow Focus Lenses – offer 2 alternatives, either use with BA or with BAL-U:

BA

Tube (with swivel mechanism for “view” and “upright”) for use of the above adaptors COA etc. with PIGRIFF-B

BAL-U

Special Bellows (with swivel mechanism for “view” and “upright”) for focusing distances closer than obtained with BA (please compare facts in the table on top of this page and note that focusing to infinity is retained)

PRALEI

Adaptor for use of screw-thread PIGRIFF (manufactured before 1965) with BA or BAL-U (240 mm lens cannot be used for focusing to infinity)

VISBA

Visoflex II/III Adaptor (“VISA + BA” or BAL-U would not allow focusing to infinity)

PIGRIFF-B

Trigger Focusing Pistol Grip

for the fastest most precise focusing, with breech-lock bayonet to accept

four lenses:

B-280

280 mm f 5.6 Noflexar with bayonet lens hood

B-400

400 mm f 5.6 Noflexar with bayonet lens hood

B-400/3

400 mm f 5.6 T-Noflexar with bayonet lens hood

corrected for increased corner sharpness

B-600

600 mm f 8 Noflexar with bayonet lens hood

ill. 2
(Exploded view of section from ill. 1)

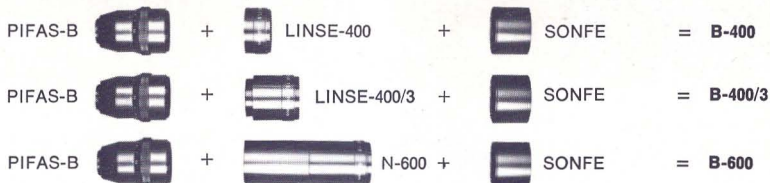

PIFAS-B
SONFE

LINSE-400
LINSE-400/3
N-600

B-400, B-400/3, B-600 have in common:
Diaphragm Barrel for LINSE-400, LINSE-400/3, N-600
Lens Hood for LINSE-400, LINSE-400/3, N-600
Consequently **three** lenses can be assembled with **one** PIFAS-B and **one** SONFE:
400 mm lens cell (+ PIFAS-B + SONFE = B-400)
400 mm lens cell (+ PIFAS-B + SONFE = B-400/3)
600 mm lens cell (+ PIFAS-B + SONFE = B-600)

New!

Components needed for Movie Cameras (listed complete, bottom page 2)

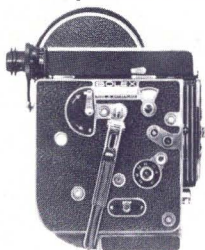

CEBA etc.



PITUB-B



PIBOLEX etc.



ill. 3
(corresponding
to ill. 1 +
components for
movie cameras)

ARBA
CEBA
PITUB-B
PIBEA-16
PIBOLEX
PIWEBO

Camera Adaptor for Arriflex
for C mount movie cameras
Extension Tube, necessary for all movie cameras
Cradle Support, necessary for Beaulieu 16 mm
for Bolex Reflex
for Pathé Webbo

No Cradle Support is necessary for Arriflex, Beaulieu 8 mm and Super 8

Accessories

PISTOCK-SK
PISTAX-K

Shoulder Pod for use of the F.F. lenses like a rifle
Adaptor for use of PISTOCK-S with Contax RTS, Yashica FX, FR
(PISTAX adapts the "Contax Cable Switch 100 cm", available from
Messrs. Yashica, to PISTOCK-S)

PISTOCK
PISTAR

Chest Pod prevents camera movement without limiting flexibility
Tripod Clamp Ring fits around 400 mm and 600 mm lenses. For use
with conventional tripods.

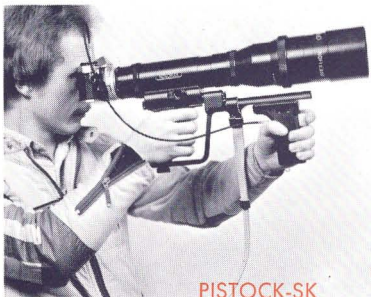

PISTOCK-SK

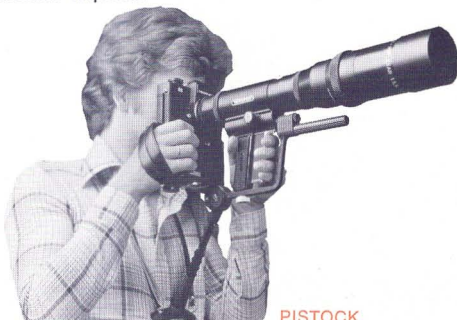

PISTOCK



PISTAR



TEX

TEX

Special Tele Extender designed for the 400 mm and 600 mm Noflexar lenses. Therefore, best possible resolution and contrast. Inserted between Camera Adaptor and BA or BAL-U: rapid interchangeability. With TEX you increase the focal length from 400 mm to 800 mm f11, from 600 mm to 1200 mm f16. In course of preparation. (ill. 1)

6 x 7, 6 x 6, 6 x 4.5 Follow Focus Lenses

(patented)



TAXPIGRIFF
BROPIGRIFF-S2C
BROPIGRIFF
HAPIGRIFF-2000
MAMPIGRIFF
NORPIGRIFF
TISPIGRIFF

Pistol Grips for split-second trigger focusing of KS-500 lens (see below). Because the rear mount is a permanent assembly, each pistol grip will fit only one series of cameras. They are not interchangeable. These grips are provided with locking knobs for time exposures.

for Asahi Pentax 6x7
 Bronica S2 and C
 Bronica, all other models
 Hasselblad 2000 FC (**not** for 500 C)
 Mamiya 645
 Norita, Rittreck, Optica II a
 Praktisix, Pentaconsix

KS-500

Lens
500 mm f6,3 Tele-Noflexar for Pistol Grips 6x6, incl. bayonet mount lens hood, length 35 cm

PISTOCK-66

Chest-pod 6x6 (same as PISTOCK, page 2, but with special strap)

★ **Adaptors** for use of 35 mm Cameras, on request

For Rollei-SL-66

The Lens Heads KS-500 (see above) and N-200 (see below) – but **not** the Pistol Grips or the Bellows – may be used with Rollei-SL-66. These lens heads are focused by using the bellows incorporated in the Rollei-SL-66:

ROLLAN

Adaptor: for use of KS-500 (focusing range 6 m – infinity) with Rollei-SL-66

ROLLAN-200

Adaptor for use of N-200 with Rollei-SL-66 (focusing range 105 cm – infinity)

N-200

200 mm f4 Noflexar, incl. bayonet lens hood

Carrying Cases for Follow Focus Lenses: see page 15

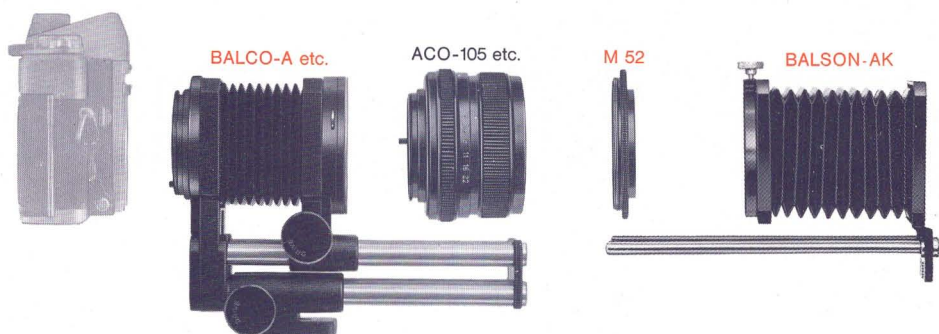

**Bellows with Automatic Diaphragm Releasing and Built-in Tripod Rack.
No double cable release required.
Permits focusing on bright ground glass at full aperture.**

BALCO-A

for Pentax and other cameras with M 42 x 1 threads

additional:

Automatic reopening of the diaphragm after exposure:

for Topcon

Miranda

with Sensorex II: light measurement at full diaphragm aperture (with the simulator set manually)

with Sensorex EE + BALMIR-AS + camera lens: light measurement with the lens stopped down.

**BALTOP-A
BALMIR-AS**

additional:

The light measured at full aperture is correct for any pre-selected smaller f-stop (open-aperture metering):

for Canon AE and EF (Canon EF may also be used with

BALCAN-AS):

Light measurement at full diaphragm aperture with ACAN-105-S and ACAN-60-S

for Canon, except AE

Contax-RTS, Yashica FX, FR

Leica R 3

Minolta

Nikon Camera Bodies with AI metering system **New!**

Nikon Camera Bodies manufactured before introduction of the AI system (AI lenses work with this bellows model, too)

Olympus

Pentax K, M

BALCAN-AE

**BALCAN-AS
BALCONT-AS
BALER-AS
BALMIN-AS
BALNIK-AI
BALNIK-AS**

**BALOM-AS
BALPENT-AS**

additional:

The camera stops down the diaphragm to the f-stop matching the pre-selected exposure time (EE Automatics):

for Konica Autoreflex, incl. T 3

BALKONI-AS

BALSON-AK

Bellows Lens Hood for Automatic Bellows

best protection against stray light, light reflections and water splashes. For slide copying, see page 12. Slip-on diameter 42 mm. For other lens diameters M-ring adaptors are required:

M 52 x 0.75

M-ring for use of BALSON-AK with 60 mm and 105 mm Auto-Bellows-Noflexar and other lenses having this filter thread for more M-rings see page 12.

Auto-Bellows for **Rolleiflex-SL-35** are distributed by Rollei agencies, exclusively.



AMIN-60-S (ACO-60 etc.)

AMIN-105-S (ACO-105 etc.)

Lens Heads with Automatic Diaphragm for Novoflex Auto-Bellows

105 mm f/4 Auto Bellows Noflexar

for close-ups **and** Tele shots, focusing range from 22 cm **to infinity**, ratio of reproduction up to 0.75 times, frame-filling shot of subjects of 3 x 4.5 cm and larger size, automatic diaphragm from f/4 to f/22

for BALCO-A

BALTOP-A

BALMIR-AS (for further information, see under BALMIR-AS)

BALCAN-AS, BALCAN-AE

BALCONT-AS

BALER-AS

BALMIN-AS

BALNIK-AI **and** BALNIK-AS **New!**

BALOM-AS

BALPENT-AS

105 mm lens head for BALKONI-AS: available only from Konica.

60 mm f/4 Auto Bellows Macro Noflexar

for photomacrography, focusing range from 8 – 15 cm, ratio of reproduction from 0.6 up to 2 times magnification, for frame-filling pictures of subjects sized 1.2 x 1.8 cm up to 4 x 6 cm. There is no gap in the focusing ranges of this and the above-mentioned 105 mm lens head. Automatic diaphragm from f/4 to f/22. Designed for top rendition in photomacrography and slide copying work, surpassing in this field even the most expensive camera lenses.

for BALCO-A

BALCAN-AS, BALCAN-AE

BALCONT-AS

BALER-AS

BALMIN-AS

BALNIK-AI **and** BALNIK-AS **New!**

BALOM-AS

BALPENT-AS

Automatic 60 mm lens heads are **not** available for BALTOP-A, BALMIR-AS, BALKONI-AS.

ACO-105
ATOP-105
AMIR-105-S
ACAN-105-S
ACONT-105-S
AER-105-S
AMIN-105-S
ANIKAI-105-S
AOM-105-S
APENT-105-S

ACO-60
ACAN-60-S
ACONT-60-S
AER-60-S
AMIN-60-S
ANIKAI-60-S
AOM-60-S
APENT-60-S

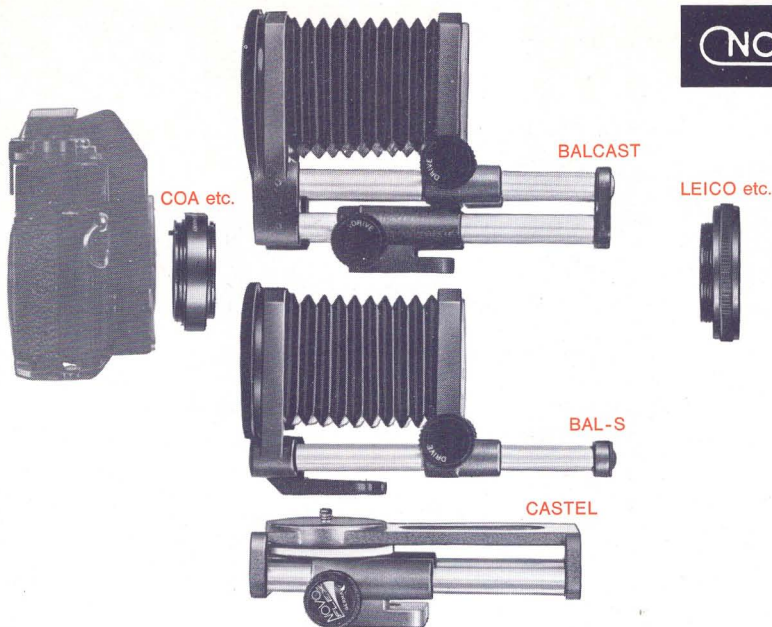

Universal Bellows Interchangeable with Different Cameras — Tripod Racks

BALCAST

Bellows Model II

breach-lock bayonet mount accepting interchangeable camera adapters, swivel mechanism for view and upright pictures. Leica thread in front accepts directly 60 mm – 200 mm lens heads (page 8–9). Built-in tripod rack.

Length of all Novoflex bellows (Minimum extension 4 cm, Maximum extension 13 cm) has been calculated so that a maximum focusing range is obtained with just the normal camera lens (50 mm – 58 mm) and a lens head (preferably 105 mm) focusing from close-up to infinity (page 10–11). At full bellows extension with a 50 mm lens magnification is approx. 3 times. At f16 depth of field is less than 2 mm which proves that the possibilities of magnification reach up to the very limits of photomacrography. (Use of a wide-angle lens with bellows for up to 5 times magnification on film.

BAL-S

Extension Bellows Model S

same as above but without tripod rack. The latter is available separately:

see page 3 and 9

see page 9

COA etc.
LEICO etc.

CASTEL

Tripod Rack

greatly facilitates focusing whenever a tripod or repro stand is used in macro and close-up photography. Also for slide-copying with BALCOP-K (see page 12–13). The tripod rack is a must in photomacrography when there is often only 1 mm difference between sharp and unsharp, too little to be corrected by moving the tripod. CASTEL may be used also for stereoscopic pictures of nonmoving subjects, including stereoscopic close-ups that cannot be achieved by any other means.

CASTEL fits any camera with a tripod thread.

VISA
ARA
DEA
CEA

Camera Adaptors: see page 3. The adaptors are the same for BALCAST, BAL-S, BA, BAL-U but BAL-U is strictly for PIGRIFF-B

Camera Adaptors not mentioned on page 3:
for use of BALCAST, BAL-S with Leica + Visoflex II/III
Arriflex
D mount cameras
C mount cameras

Adaptors for Use of Camera Lenses

with BALCAST, BAL-S

and for use of X-SHOE and X-39 (page 14) with lenses in reversed position

(No adaptor required for Novoflex lens heads, pages 10—11)

for Canon lenses

M 42 × 1 lenses (Praktica etc.)

same, but for lenses with cable release nipple

Contax RTS, Yashica FX lenses

Exakta/Exa/Topcon lenses

Konica lenses

Leica lenses

Leicaflex, Leica R 3 lenses

Leitz Elmar, Elmarit 90 mm lenses

Minolta lenses

Miranda lenses

Nikon lenses

Olympus OM lenses

Asahi Pentax K, M lenses

Praktina lenses

Arriflex lenses

C mount movie camera lenses

LEICAN
LEICO
LEICO-D
LEICONT
LEIEX
LEIKONI
LEI-M
LEI-F
LEIEL
LEIMIN
LEIMIR-B
LEINIK
LEIOM
LEIPENT
LEIPRA
LEIAR
LEICE

BALCAST

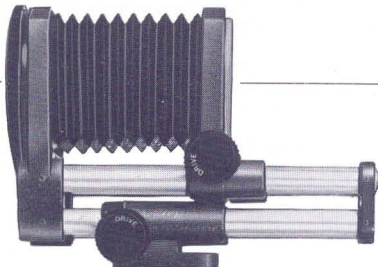

BALFLEX



BALSON-K

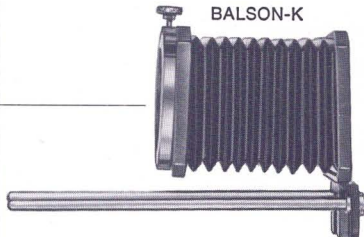

COA
etc.

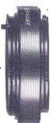

LEINO-105



BAL-S

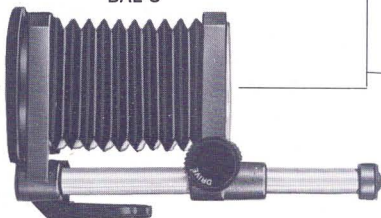

LEIAN



N-200



NORING

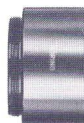

Lens Heads for Use with BALCAST, BAL-S

Quality lenses at low prices, because no helical mounts are required. The bellows provide very wide focusing ranges (see table, also for an other technical data). Long focal length lens heads make frame-filling shots of small subjects possible without approaching the subject too closely (important for taking pictures of shy insects etc.), avoid ugly deformations, disturbing backgrounds, or fence wires in the foreground, bring the subjects closer across fences or other obstacles.

BALFLEX	60 mm f4 Noflexar , click-stop diaphragm setting ring f4-16, length 28 mm (see page 12)
LEINO-105	105 mm f4 Noflexar , milled rubber covered diaphragm setting ring, length 29 mm
LEINO-200	200 mm f4 Noflexar incl. bayonet lens hood, length 14.3 cm, consisting of: 200 mm f4 Noflexar lens head Leica thread adaptor for N-200
N-200 LEIAN	
NORING	24 mm extension tube with Leica threads. Can be used to increase extension of the bellows to obtain larger reproduction ratios (see table).
BALSON-K	Bellows Lens Hood , best protection against stray light, light reflexions and water splashes. Can be used with bellows BALCAST, BAL-S and lens heads 60 mm — 105 mm (42 mm slip-on diameter). For 50 mm — 58 mm camera lenses with other diameters we supply M-ring adaptors. See page 12, also for slide-copying.

Filters: available from B + W, Cenei, Heliopan. Novoflex does **not** supply filters.

Adaptors for the Manual Use of BALFLEX, LEINO (see above) and other Leica thread lenses

on Automatic Bellows

CANLEI-K
COLEI
EXLEI-K
MINLEI-K
NIKLEI-K
MIRLEI

for **BALCAN-AS**
BALCO-A
BALTOP-A
BALMIN-AS
BALNIK-AS, BALNIK-AI
BALMIR-AS

Lenses for Slide Copying

with Automatic Bellows Attachments (BALCO-A, BALCAN-AS etc.)
60 mm Auto-Bellows-Macro-Noflexar (see page 7) + M 52 x 0.75 or
50 mm Camera Lens + M-Ring or
60 mm BALFLEX + Adaptor (see above)

with BALCAST or BAL-S
60 mm BALFLEX (see top of this page)

Copy Your Slides

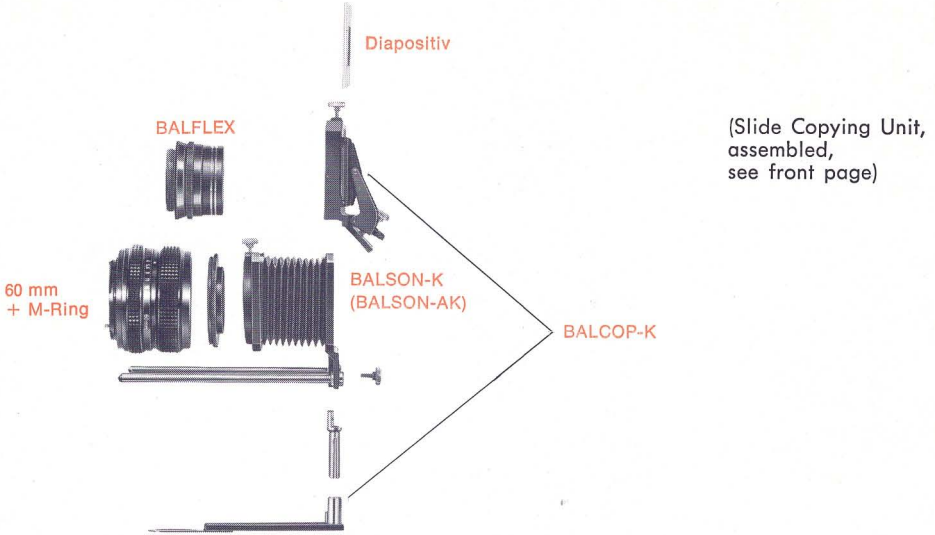

and, of course, your negatives; or reverse your slides and negatives. This equipment enables you to deal with full or masked frame, or with any portion of the original. All components, except BALCOP-K, serve other uses. The following components are required

BALSON-AK

Bellows Lens Hood for Auto-Bellows BALCO-A, BALMIN-AS etc. variable extension, keeps the slide copier at the distance required for ratio of reproduction desired. For photography in general, gives best protection against stray light, light reflections or water splashes. Slip-on diameter 42 mm, fitting BALFLEX and LEINO-105 direct. M-ring adaptors are necessary for other lens diameters.

BALSON-K

Bellows Lens Hood for Novoflex Bellows BALCAST, BAL-S

BALCOP-K

Slide Copying Attachment

enables the operator to keep the subject centrally in front of the lens, whether it is the whole of a slide or negative, mounted or in strip form, or any section of a frame. BALCOP-K is supplied with a bracket connecting BALSON-K or BALSON-AK to the tripod rack, thus offering more convenience in focusing. Which lenses to use, see page 11 below.

BALFLEX

60 mm f4.5 Special Lens. Formulated for photomacrography, this lens will reproduce at 0.6 x to 2 x, which means that subjects sized 12 mm x 18 mm can fill the frame. 42 mm slip-on diameter (fitting BALSON-AK or BALSON-K without M-ring). Leica threads fit BALCAST, BAL-S direct.

For use with Auto-Bellows an adaptor COLEI, etc., (see page 11) is necessary.

BALFLEX is excellent for use as an enlarging lens.

M-ring adapting BALSON-AK, BALSON-K to the filter threads of various lenses. When ordering an M-ring, please specify

M-ring for lenses with M 49 x 0.75 filter threads

M-ring for lenses with M 52 x 0.75 filter threads

M-ring for lenses with M 55 x 0.75 filter threads

M-ring for Icarex camera lenses

M-ring for lenses with other filter threads are made to special order.

Quote filter thread size. (Delivery delay 8 weeks approx.)

M 49 x 0.75

M 52 x 0.75

M 55 x 0.75

M-IC

M.....

The Novoflex Macro Stand

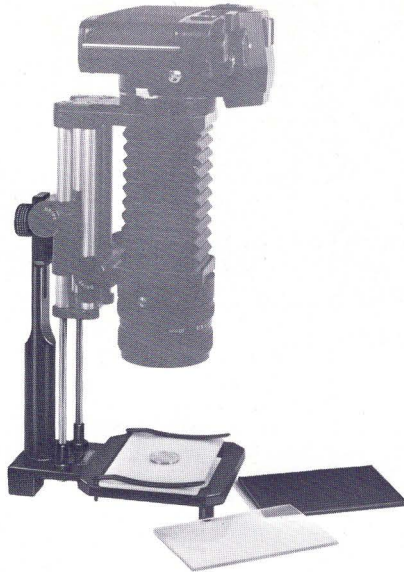

MACRO

The Novoflex Macro Stand (Code: MACRO) makes photomacrography with the Novoflex Auto-Bellows or BALCAST easy: Film plane and subject carrier are, without adjustment by the photographer, always parallel. Three subject carriers – one glass, one opal, one aluminium (covered one side with black velvet, the other painted light grey). The subject carriers and the subject can be retained by two clips, enabling the outfit to be used on the table (with both hands free for arranging the subject), or handheld with perhaps the sky for a background. There is little risk of camera shake, as the Macro Stand is mounted directly onto the tripod rack to form one unit. For use of the Novoflex Macro Stand it is necessary to have an Automatic or BALCAST Novoflex Bellows Attachment, or (with extension tubes) the Tripod Racks CASTEL. Its dimensions are calculated for photomacrography, consequently for 60 mm and shorter focal length lenses. Recommended accessories: 60 mm Macro-Novoflexar, Flash Holder X-SHOE, (Reversal rings for wide-angle lenses and the above mentioned light box are available from the manufacturers, not from Novoflex!)





Novoflex Flash Bracket for Macro and Close-up Photography

offers the following advantages:

- 1) Both hands are free to operate the camera. No tripod required.
- 2) The flash reflector may be attached close to the lens. This is very important when taking pictures of very close subjects.
- 3) The flash reflector may be attached on the right, left or upper side of the lens.
- 4) The flash reflector may be angled precisely at the subject. This is possible even when the subject is as close as 1 inch. The Novoflex Flash Bracket may also be used for bouncing the light from the ceiling.
- 5) The flash unit may be attached parallel or at right angles to the front of the lens.
- 6) Using two X-ring adaptors and two Flash Brackets it is possible to attach 2 flash units, e.g. for reproduction where it is desirable to have two light sources one from each side at angles for an even and reflection-free illumination.
- 7) A Bellows Lens Hood (BALSON-K or BALSON-AK) may be used at the same time.
- 8) Interchangeable X-ring adaptors (e.g. X 52 x 0.75) attach the Flash Bracket X-SHOE to the filter thread of various lenses. Filters may be used at the same time. The X-SHOE is slipped over the X-ring adaptor and safely clamped in any position.
- 9) Once the exposure has been determined for a particular close-up distance, no further calculation is required for variations in bellows extension. The closer the subject, the greater the exposure required. But the light-source also moves in closer, thus automatically compensating for the required exposure increase.
- 10) Even tiny flash units can cause overexposure in close-up photography. Our flash Bracket is therefore supplied with 2 diffusers fitting most pocket-size flash units. It doesn't matter if the diffusers are smaller than the flash reflector, because it is only the central light rays that strike the close-up subject.

X-SHOE X-39

X-40.5 x 0.5
X-48 x 0.75
X-49 x 0.75
X-52 x 0.75

X-55 x 0.75
X-58 x 0.75
X.....

Flash Bracket as described above

X-ring adaptor for use of X-SHOE with lenses in reversed position. A second adaptor (see page 9, LEICAN etc.) is necessary.

X-ring adaptor for 60 mm BALFLEX, LEINO-105

X-ring adaptor for lenses with filter threads M 48

X-ring adaptor for lenses with filter threads M 49

X-ring adaptor for 60 mm and 105 mm Auto-Bellows-Noflexar and other lenses with filter threads M 52

X-ring adaptor for lenses with filter threads M 55

X-ring adaptor for lenses with filter threads M 58

X-ring adaptors according to your filter thread specifications on request (delivery delay 8 weeks approx.)

X-ring adaptors made on request have no filter threads in front and corner vignetting may occur with lenses requiring X 58 or larger diameter threads.



TAS



TASUNI

Carrying Cases

TAS

Ever-ready Case for a complete Follow Focus equipment up to 400 mm focal length and camera attached (or 500 mm, page 5, without camera), plus space for accessories like N-600, PISTOCK etc.

TASUNI

Universal Carrying Case, stylish, rugged, light-weight (only 2.1 kg), ext. dimensions 45 x 34 x 9,5 cm, with interchangeable foam rubber lining uncut, space for 400 mm Follow Focus lens with Special Bellows, camera adaptors, Bellows Model with Tripod Rack and complete slide copying equipment etc.

Rubber Dust Caps

DUSTA
DUSTCAN
DUSTCO
DUSTCONT
DUSTER
DUSTEX
DUSTFE
DUSTHI
DUSTHI/3
DUSTKONI
DUSTLEI
DUSTMIN
DUSTMIR
DUSTNIK
DUSTOM
DUSTPNT
DUSTPI
DUSTPRA

for front of Auto-Bellows-Noflexar lenses

Canon bayonet
Asahi Pentax threads
Contax RTS bayonet
Leica R 3 bayonet
Exakta bayonet
front of 400 mm and 600 mm lenses
rear end of LINSE-400 and N-600
rear end of LINSE-400/3
Konica bayonet
Leica threads
Minolta bayonet
Miranda bayonet
Nikon bayonet
Olympus OM 1 bayonet
Asahi Pentax K bayonet
front of 280 mm lens
rear end of pistol grip and of 280 mm, 400 mm lens heads

Dieter Gabler

Vollendete Spiegelreflex- Fotografie mit

NOVOFLEX

Fotografieren und Filmen mit Novoflex-Geräten

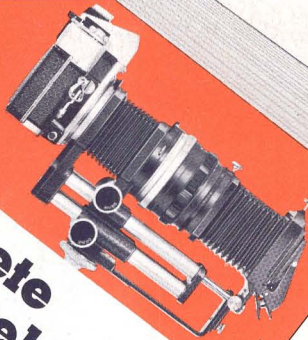

Novoflex Manual:
available in German
language, only

Novoflex offers the Maximum of

PRECISION
RUGGEDNESS
USEFULNESS
VERSATILITY
SHARPNESS
BRILLIANCE

Articles not mentioned in this catalogue, such as filters, adaptors for use of camera lenses with cameras having other lens connecting mounts are **not** available from us. Production of single items to special order would be so expensive as to be impracticable.

In the interests of progress, the manufacturers reserve the right to make technical modifications without notice.

Catalogue printed Jan. 1978

NOVOFLEX Fotogerätebau Karl Müller

D-8940 Memmingen

Tel. (083 31) 33 76

Printed in Germany

FISHER PHOTO

200

KRX

NOVOFLEX

A to Z List of Cameras

	Complete Follow Focus Lenses) please add focal length: -280 -400- -400/3- -600- (mm)		Adaptors for Bellows Model BALCAST, BAL-S (same as for BAL-U)	Auto-Bellows + Auto-Bellows-Noflexar lenses	6×7, 6×6, 4.5×6 Follow Focus Pistol Grips for KS-500
	with rigid adaptor page 2	with special bellows page 2			
Alpa	ALPI-*B	ALPI-*U	ALA		
Arriflex	ARPI-*B		ARA		
Beaulieu Super 8	BEAPI-S-*B		CEA		
Beaulieu 16 mm	BEAPI-16-*B		CEA		
Bolex Reflex	BOLPI-*B		CEA		
Bronica S2 and C					BROPIGRIF-S2C
Canon	CANPI-*B	CANPI-*U	CANA	BALCAN-AS+ACAN-105-S ²	
Canon AE, EF	CANPI-*B	CANPI-*U	CANA	BALCAN-AE+ACAN-105-S ²	
Chinonflex	COPI-*B	COPI-*U	COA	BALCO-A+ACO-105 ²	
Contarex	REXPI-*B	REXPI-*U	REXA		
Contax RTS	CONTPI-*B	CONTPI-*U	CONTA	BALCONT-AS+ACONT-105-S ²	
Cosina	COPI-*B	COPI-*U	COA	BALCO-A+ACO-105 ²	
Edixa(-mat) Reflex	COPI-*B	COPI-*U	COA	BALCO-A+ACO-105 ²	
Elbaflex, Exa(kta) II/VX	AUXPI-*B	AUXPI-*U	AUXA		
Exakta Twin TL	TWINPI-*B	TWINPI-*U	TWINA		
Fuji ST 701 - 901	COPI-*B	COPI-*U	COA	BALCO-A+ACO-105 ²	
Hasselblad 2000 FC					HAPIGRIF-2000
Icarex BM	ICAPI-*B	ICAPI-*U	ICAA ¹		
Icarex TM	COPI-*B	COPI-*U	COA	BALCO-A+ACO-105 ²	
Konica Autoreflex T, T3	KONUPI-*B	KONUPI-*U	KONIA	BALKONI-AS	
Leica + Visoflex II/III	VISPI-*B		VISA		
Leicaflex, SL, SL 2	LERPI-*B	LERPI-*U	LEA-R		
Leica R 3	LERPI-*B	LERPI-*U	LEA-R	BALER-AS+AER-105-S ²	
Leicina-SPECIAL ³					
Mamiya Reflex	IXPI-*B	IXPI-*U	IXA		
Mamiya Sekor	COPI-*B	COPI-*U	COA	BALCO-A+ACO-105 ²	
Mamiya 645					MAMPIGRIF
Mamiya NC 1000 S	COPI-*B ⁴	COPI-*U ⁴	COA ⁴	BALCO-A+ACO-105 ⁴	
Minolta SR, XM, XE	MINPI-*B	MINPI-*U	MINA	BALMIN-AS+AMIN-105-S ²	
Miranda	MIRPI-*B	MIRPI-*U	MIRA	BALMIR-AS+AMIR-105-S	
Nikon, Nikkorex, Nikormat	NIKPI-*B	NIKPI-*U	NIKA	BALNIK-AS+ANIKAI-105-S ²	
Nikon AI-System	NIKPI-*B	NIKPI-*U	NIKA	BALNIK-AI+ANIKAI-105-S ²	
Norita, Rittreck, Optica II a					NORPIGRIF
Olympus FTL	COPI-*B	COPI-*U	COA	BALCO-A+ACO-105 ²	
Olympus OM	OMPI-*B	OMPI-*U	OMA	BALOM-AS+AOM-105-S ²	
Pathé Webó	WEBPI-*B		CEA		
Pentacon, Asahi Pentax	COPI-*B	COPI-*U	COA	BALCO-A+ACO-105 ²	
Pentaconsix					TISPIGRIF
Asahi Pentax K, M	PENTPI-*B	PENTPI-*U	PENTA	BALPENT-AS+APENT-105-S ²	
Asahi Pentax 6×7					TAXPIGRIF
Petriflex	PEPI-*B	PEPI-*U	PEA ¹		
Praktica	COPI-*B	COPI-*U	COA	BALCO-A+ACO-A-105 ²	
Praktina	PRAPI-*B	PRAPI-*U	PRAA		
Praktisix					TISPIGRIF
Regula Reflex, Revueflex	COPI-*B	COPI-*U	COA	BALCO-A+ACO-105 ²	
Ricoh Singlex	COPI-*B	COPI-*U	COA	BALCO-A+ACO-105 ²	
Rolleiflex-SL-35, -350	ROLPI-*B	ROLPI-*U	ROLA ¹	available from Messrs. Rollei	
Rollei-SL-66					ROLLAN (NO grip available)
Topcon SR	IXPI-*B	IXPI-*U	IXA	BALTOP-A+ATOP-105	
Voigtlander VSL 1	COPI-*B	COPI-*U	COA	BALCO-A+ACO-105 ²	
Yashica Reflex	COPI-*B	COPI-*U	COA	BALCO-A+ACO-105 ²	
Yashica FX, FR	CONTPI-*B	CONTPI-*U	CONTA	BALCONT-AS+ACONT-105-S ²	
Zeiss Ikon SL 706	COPI-*B	COPI-*U	COA	BALCO-A+ACO-105 ²	
Zenit with M 42×1 threads	COPI-*B	COPI-*U	COA	BALCO-A+ACO-105 ²	
Zenit with Leica threads	ZENPI-*B	ZENPI-*U	ZENA		

¹) NO adaptor for use of camera lenses available

²) also available: a 60 mm Auto-Bellows-Macro-Noflexar

³) any Novoflex equipment with the code-word syllables VIS, LE, MIN, CO can be adapted to Leicina-S with corresponding Leitz adaptors.

⁴) for use with another adaptor available from the camera manufacturer, only.

CO is the code-word prefix for the **M 42×1 threads**, eg. COPI-400-B = Follow Focus Lens with M 42×1 threads.

This code-word prefix was chosen when the first camera featuring these threads was the "Contax-S".

In the meantime, more than 10 cameras are equipped with M 42×1 threads as can be seen from the above list.

Not listed above are code-words for articles that are the same for any of these cameras, such as B-280, LEINO-105, CASTEL etc.

Novoflex Lenses 60 mm - 600 mm

There may be other quality lenses of same focal length, but none can cope with the rapidity of focusing, range and versatility of the Novoflex lenses.

Focal Length	Designation	Diaphragm	Angle of View	a) focusing range b) magnification c) subject size frame-filling WITHOUT Bellows	a) focusing range b) magnification c) subject size frame-filling WITH Bellows	Filter threads	Lens Hood	Catalogue Page	Code-word	for
60 mm	Noflexar	4 - 16 click-stop	39°		8 - 15 cm 0.6 - 2 times 1.2x1.8 cm	40.5x0.5	BALSON-K	11, 12	BALFLEX	BAL-S and BALCAST Bellows ¹
60 mm	Auto-Bellows-Macro-Noflexar	4 - 22 automatic	39°		8 - 15 cm 0.6 - 2 times 1.2x1.8 cm	52x0.75	BALSON-AK + M 52x0.75	7	ACO-60 ACAN-60-S ACONT-60-S AER-60-S AMIN-60-S ANIKAI-60-S AOM-60-S APENT-60-S	Auto-Bellows - BALCO-A Auto-Bellows - BALCAN-AS, BALCAN-AE Auto-Bellows - BALCONT-AS Auto-Bellows - BALER-AS Auto-Bellows - BALMIN-AS Auto-Bellows - BALNIK-AS, BALNIK-AI Auto-Bellows - BALOM-AS Auto-Bellows - BALPENT-AS
105 mm	Auto-Bellows-Noflexar	4 - 22 automatic	24°		22.5 cm - infinity 0.75 times 3x4.5 cm	52x0.75	BALSON-AK + M 52x0.75	7	ACO-105 ACAN-105-S ACONT-105-S AER-105-S AMIN-105-S AMIR-105-S ANIKAI-105-S AOM-105-S APENT-105-S ATOP-105	Auto-Bellows - BALCO-A Auto-Bellows - BALCAN-AS, BALCAN-AE Auto-Bellows - BALCONT-AS Auto-Bellows - BALER-AS Auto-Bellows - BALMIN-AS Auto-Bellows - BALMIR-AS Auto-Bellows - BALNIK-AS, BALNIK-AI Auto-Bellows - BALOM-AS Auto-Bellows - BALPENT-AS Auto-Bellows - BALTOP-A
105 mm	Noflexar	4 - 32 click-stop	24°		22.5 cm - infinity 0.75 times 3x4.5 cm	40.5x0.5	BALSON-K	11	LEINO-105	BAL-S and BALCAST Bellows ¹
200 mm	Noflexar	4 - 22 click-stop	12°		67 cm - infinity 0.4 times 6x9 cm	58x0.75	incl. bayonet lens hood	11	LEINO-200 (=N-200+LEIAN)	BAL-S and BALCAST Bellows ¹
200 mm	Noflexar	4 - 22 click-stop	20°		105 cm - infinity	58x0.75	incl. bayonet lens hood	5	N-200+ROLLAN-200	ROLLEI-SL-66
280 mm	Noflexar	5.6 - 32 click-stop	9°	420 cm - infinity	100 cm - infinity 0.4 times 6x9 cm	58x0.75	incl. bayonet lens hood	2-3	B-280+PIGRIF-B + Camera Adaptor	all 35 mm cameras listed under "A to Z" (back of this page)
400 mm	Noflexar	5.6 - 32 click-stop	6°	820 cm - infinity	180 cm - infinity 0.3 times 8x12 cm	75x0.75	incl. bayonet lens hood	2-3	B-400 (or B-400/3) + PIGRIFF-B + Camera Adaptor	all 35 mm cameras listed under "A to Z" (back of this page)
500 mm	Tele-Noflexar	6.3 - 32 click-stop	8°	1325 cm - infinity		49x0.75 ²	incl. bayonet lens hood	5	KS-500+BROPIGRIF KS-500+BROPIGRIF-S2C KS-500+HAPIGRIF-2000 KS-500+TAXPIGRIF KS-500+TISPIGRIF KS-500+NORPIGRIF KS-500+MAMPIGRIF	Bronica Bronica-S, 2C Hasselblad 2000 FC (in preparation) Asahi Pentax 6x7 Pentaconsix, Praktisix Norita, Rittreck, Optica II a Mamiya 645
500 mm	Tele-Noflexar	6.3 - 32 click-stop	8°	600 cm - infinity		49x0.75 ²	incl. bayonet lens hood	5	KS-500+ROLLAN	Rollei-SL-66
600 mm	Noflexar	8 - 32 click-stop	4°	1660 cm - infinity	380 cm - infinity 0.2 times	75x0.75	incl. bayonet lens hood	2-3	B-600+PIGRIF-B + Camera Adaptor	all 35 mm cameras listed under "A to Z" (back of this page)

¹⁾ Lens Head fitting BALCAST, BAL-S direct
 Lens Head fitting BALCO-A with adaptor COLEI
 Lens Head fitting BALCAN-AS, AE with adaptor CANLEI-K
 Lens Head fitting BALTOP-A with adaptor EXLEI-K
 Lens Head fitting BALMIN-AS with adaptor MINLEI-K
 Lens Head fitting BALNIK-AS with adaptor NIKLEI-K

²⁾ filter threads at the rear end of the lens head

The focusing ranges indicated were measured from the front of the lenses to the subject. Focusing ranges may vary depending on camera in use.

Focusing range of 50 mm - 58 mm camera lenses with Novoflex Bellows:
 7-4 cm approx., magnification 1:1 up to 3 times, subjects sized 0.9x1.4 cm
 may be reproduced frame-filling on 35 mm film.
 1 in. = 2.54 cm = 25.4 mm
 1 m = 100 cm = 1000 mm = 3.281 ft.
 1 cm = 10 mm = 0.3937 in.
 Printed in Germany